

PO Box 74212,
Turffontein
2140
93 Turffontein Rd
Turffontein
2140



Reg # 2014/283980/07
Vat No # 4640273258
Tel No: +27 10 900 4500
Fax No: +27 11 434 1594

COMPANY PROFILE



Umqondo Marketing & Consulting (Pty) Ltd was established in 2014. We supply Mining, General Industry and Engineering Training Centre's. In addition, Umqondo is a registered vendor on the Central Supplier Data base (CSD) for all Government opportunities. We confirm that Umqondo Marketing and Consulting (Pty) Ltd is an Exempted Micro Enterprise (EME) with a scorecard of Level 2 that has 51% Black Woman Ownership and has been verified as an empowering supplier in terms of the DTI Codes of Good Practice. We are a direct importer of quality industrial hand tools and our stockholding consists of the following product groupings: Hand & Power Tools, Striking Tools, Precision measuring equipment, Toolkits for all Artisan disciplines, Electronic test equipment, Drills, Cutting, Taps, Dies & Production Tooling, Locks and Safety Lockout Systems, Lifting Equipment, Welding Machines and consumables and PPE.

We have developed strong relationships with our clients as we focus on the following key elements:

- . Absolute Integrity and fair dealings.
- . Strong Company Ethos and Values
- . Quality Products fit for use in industry
- . Competitive Pricing
- . Qualified Technical Representatives
- . Stable trained and Multi Skilled staff
- . Stock Holding, Warehousing & Distribution
- . Understanding Service Levels and Customer Expectations
- . Strategic Alliances with Manufacturers

The management of Umqondo has more than 50 years' experience in sourcing and supplying industry. Our network ensures the capacity is available in all areas to offer comprehensive after sales service.

Please do not hesitate to contact us should you require any further information.



TOOLKITS



CUTTING TOOLS



LOCKS



SKD



SANDO

UNBREAKABLE STRIKING TOOLS

HAMMERS



INGCO

PROFESSIONAL TOOLS MADE AFFORDABLE



Umqondo

Marketing & Consulting

Umqondo are specialist suppliers of Toolkits into industry and artisan training centres.

Toolkits can be made up to specific customer requirements for all artisan disciplines.

For a free quote contact our offices in Turfontein on:

Tell: 010 900 4500

Fax: 011 434 1594

Email: sales@umqondo.com

TOOLKITS



TOOLKITS

MOTOR DIESEL TOOLKIT

HANDLE FILE PLASTIC 110MM LRG	PLIER W/PUMP 250MM CRV
FILE FLAT 2C CUT 300MM BULK	WRENCH PIPE 250MM
FILE HR 2C CUT 300MM BULK	WRENCH PIPE 350MM
FILE 3 SQ 2C CUT 300MM +HNDL	SAFETY SPECTACLES ADJUSTABLE
FILE RND 2C CUT 300MM BULK	TAPE MEASURE R/CASE 3M X 16MM
FILE SQ 2C CUT 300MM BULK	KNIFE UTIL.RETRACT 61X19MM+6BL
FILE BAG CANVAS	RULE S/S 300MM X 28MM
BAR TOMMY 19X450MM	FEELER GAUGE 32BL 0.02-1.0MM
BRUSH FILE 115X40MM	CALIPER I/S SPRING 150MM
TRUNK STEEL 660X340X260 26/660	DIVIDER JOINT SPRING 150MM
HACKSAW FRAME 20 T	SCRIBER DBL END 250MM
SPANNER COMB 1B SET 1B/017A	SHIFTER MAXPOWER 450MM
OIL CAN FIXED&FLEX SPOUT 500ML	A/KEY 9PC 1.5-10MM STD BLK
PUNCH CENTRE 5X10X140MM	A/KEY 9PC 1/16-3/8 STD BLK
PADLOCK BRASS 40MM H/D	AUTO WRENCH STRAP 225MM
WRENCH ADJ CRV 250MM	CALIPER O/S SPRING 150MM
PLIER CIRCLIP 180MM STR EXT	SPANNER SET 6-24MM 18PC
PLIER CIRCLIP 180MM STR INT	FILE FLAT B/CUT 300MM BULK
VICEGRIP CURVED JAW 250MM	HAMMER BP 226G WOOD HANDLE
PLIER DIAGONAL 180MM CR-V	HAMMER BP 450G WOOD HANDLE
PLIER COMB 200MM HL CR-V	VERNIER 150MM METRIC .02 GRADE
PLIER L/NOSE 200MM HL CR-V	SQUARE ENGINEERING 150MM
PUNCH PIN SET 6PCS	HAMMER S/FACE NON-RECOIL 50MM
SOCKET SET 24PCS 1/2DR	S/DRIVER SET BT 1734 6PCE GR



BOILER MAKER TOOLKIT

CALCULATOR SCIENTIFIC EL531	HACKSAW FRAME 20 T
RULE LINE OF CHORDS 600MM	FLINTLIGHTER
ANGLE GRINDER 950W 115MM	HAMMER S/FACE NON-RECOIL 50MM
PLIER TINSNIP STR H/D 250MM	PRICK PUNCH 100MM
HAMMER BP 450G WOOD HANDLE	BEVEL SQUARE 200MM
HAMMER BP 900G WOOD HANDLE	SQUARE SET 26CM 45
SQUARE RAFTER 400 X 600MM	SQUARE SET 26CM 60
HAMMER CLUB 1.8KG R/HNDL	LEVEL ALUMINIUM 60CM 3 VIAL
PENCIL CLUTCH AND LEAD 0.7	RULE S/S 300MM X 28MM
CURVOMARK MARKER CONTOUR STD	RULE S/S 600MM X 28MM
CURVOMARK RADIUS MARKER STD	RULE S/S 1000MM X 30MM
CURVOMARK CENTRE HEAD STD	WRENCH ADJ CRV 250MM
SQUARE COMBINATION SET 300MM	CHALK LINE REEL SET 3 PCE
SPANNER SET 6-32MM 26PC BOX	TRUNK C/W SLT&TRAY 650X290X280
DIVIDER JOINT SPRING 200MM	TAPE MEASURE R/CASE 5M X 19MM
SCRIBER DBL END 250MM	VERNIER 150MM METRIC .02 GRADE
SQUARE ENGINEERING 150MM	VICEGRIP CURVED JAW 250MM
BRUSH FILE 115X40MM	APRON CHROME LEATHER GBL0060
FILESET 250MM 5PCE	BRUSH WIRE 4 ROW 250 WOOD HNDL
FLEXI CURVE 600MM	WELDING GOGGLES PVC F/FRONT
PLIER FENCING 250	S/DRIVER SET BT 1734 9PCE GR



TOOLKITS

ELECTRICAL TOOLKIT

BRUSH FILE 115X40MM	LEVEL TORPEDO 225MM MAGNETIC
TOOLBOX FOLDOUT 550 5/TRAY	PLIER W/PUMP 250MM CRV
HACKSAW FRAME 20 T	SAFETY SPECTACLES ADJUSTABLE
MINI HACKSAW FRAME	STEEL MEASURING TAPE 3Mx16MM
CHISEL COLD FLAT 20X200MM	KNIFE UTIL.RETRACT 61X19MM+6BL
PUNCH CENTRE 5X10X140MM	WIRE STRIPPER AUTOMATIC 180MM
PADLOCK BRASS 40MM H/D	RULE S/S 300MM X 28MM
WRENCH ADJ CRV 200MM	DIVIDER JOINT SPRING 150MM
WRENCH ADJ CRV 250MM	SCRIBER DBL END 250MM
VICEGRIP CURVED JAW 250MM	PLIER TINSNIP CRV 250MM
PLIER COMBINATION 200MM CRV	A/KEY 9PC 1.5-10MM STD BLK
PLIER DIAGONAL H/D 180MM CR-V	A/KEY 9PC 1/16-3/8 STD BLK
PLIER L/NOSE 200MM HL CR-V	S/DRIVER 6PC CRV VDE INSUL.
FILE FLAT 2C CUT 250MM BULK	PLIER CRIMP INSUL 0.5-6.0
FILE HR 2C CUT 250MM BULK	SPANNER SET 6-24MM 18PC
FILE 3 SQ 2C CUT 250MM BULK	SPANNER COMBI DEEP OFFSET 26MM
FILE RND 2C CUT 250MM BULK	TOP TRONIC MULTIMETER TBM811
FILE SQ 2C CUT 250MM BULK	SPANNER SET TUBE NO.53B 0-10BA
FILE FLAT B/CUT 300MM BULK	FILE FLAT 2C CUT 200MM BULK
HANDLE FILE PLASTIC 95MM MED	PRICK PUNCH 100MM
HANDLE FILE PLASTIC 110MM LRG	HAMMER BP 226G WOOD HANDLE
FILE BAG CANVAS	HAMMER BP 450G WOOD HANDLE
SOCKET SET 24PCS 1/2DR	SQUARE ENGINEERING 150MM



INSTRUMENTATION TOOLKIT

TOOLBOX FOLDOUT 550-5/TRAY	WIRE STRIPPER AUTOMATIC 180MM
HACKSAW FRAME 20 T	A/KEY 9PC 1.5-10MM STD BLK
MINI HACKSAW FRAME	A/KEY 10PC 1/16-1/2 STD BLK
SPANNER SET INCL TOMMYBAR 7PCE	HAMMER BP 226G WOOD HANDLE
PADLOCK BRASS 38MM L/D	FILE SET NEEDLE 6PCE 140MM
WRENCH ADJ CRV 200MM	PLIER CRIMPING LUG 1.25-8MM
WRENCH ADJ CRV 250MM	NUT DRIVER DWALL 10MM S/GRIP
PLIER BENT NOSE 160MM CR-V	NUT DRIVER DWALL 12MM S/GRIP
PLIER CIRCLIP 180MM STR EXT	NUT DRIVER DWALL 13MM S/GRIP
PLIER CIRCLIP 180MM STR INT	NUT DRIVER 8MM
VICEGRIP CURVED JAW 250MM	SOCKET SET 24PCS 1/2DR
PLIER COMB 200MM POLISHED	SPANNER SET 6-24MM 18PC
PLIER DIAGONAL 180MM CR-V	SPANNER COMB 1B SET 1B/017A
PLIER L/NOSE 200MM HL CR-V	HELLERMANN TESTER TBM811
S/DRIVER 6PC CRV VDE INSUL.	TUBE SPANNER SET 0-10BA
S/DRIVER SET JEWELERS 6PC	CENTRE PUNCH 5X8X100
LEVEL TORPEDO 225MM MAGNETIC	TOOL ASST TRAY 5PCE FILE SET
PIPE CUTTER PVC 225MM 3-42AUTO	RULE S/S 300MM X 28MM
PLIER W/PUMP 250MM CRV	SCRIBER DBL END 250MM
SAFETY SPECTACLES ADJUSTABLE	SQUARE ENGINEERING 150MM
KNIFE UTILITY RETRACTABLE	S/DRIVER SET BT 1734 9PCE GR



TOOLKITS

FITTER & TURNER TOOLKIT

1/2" DRIVE SOCKET SET (28 PCE) 8-32MM	LONG NOSE PLIERS 200MM
PADLOCK BRASS 38MM	NEEDLE FILE SET 180MM (12 PC)/ HANDLE
BALL PEIN HAMMER 220G	NON RECOIL SOFT FACE HAMMER 50MM
BALL PEIN HAMMER 450G	OIL CAN 500ML WITH FLEX & RIGID SPOUT
CENTRE PUNCH	OUTSIDE SPRING JOINT CALIPER 150MM LONG
OFFSET COMBINATION SPANNER 26.0MM	POLY CARBON SAFETY GLASSES
6-24/19 COMBINATION SPANNERS BOX	HACKSAW FRAME ALU HANDLE FRONT NUT
DIVIDER SPRING JOINT 150MM LONG	6 PIECE PUNCH & CHISEL SET
DIAGONAL CUTTERS 180MM	PIPE WRENCH 250MM MAX JAW OPENING 45MM
DOUBLE END STEEL SCRIBER	PIPE WRENCH 350MM MAX JAW OPENING 50MM
SILVERLINE COMBINATION PLIERS 200MM	KNIFE UTILITY RUBBER GRIP PUSH BUTTON
CIRCLIP PLIERS EXTERNAL STRAIGHT 175MM	150MM STEEL RULE
150MM ENGINEERS STEEL SQUARE	300MM STEEL RULE
ENGLISH TIN SNIPS 300MM CUTS 0.91MM	SHIFTING SPANNER 250MM
FILE BRUSH 50X25	SHIFTING SPANNER 450MM
FEELER GAUGE 26 LEAF IMPERIAL	TOMMY BAR 450MM LONG
FILE SET 250MM FLAT, HR, TRI, RND & SQ 2ND	TOOLBOX CHEST 660X370X285
300MM FLAT FILE BASTARD	STEEL MEASURING TAPE YELLOW CASE 3X16MM
PLASTIC FILE HANDLE 250MM, 300MM	LEVEL MAGNETIC 230MM
GEDORE COMBI SPANNER SET 1B/017A	150MM VERNIER 0.02MM
STD HEX KEY SET 1.5-10MM BOX	VICE GRIP 250MM
STD HEX KEY SET 1/16-3/8 BOX	WERA SCREWDRIVERS SET 9 PIECES
INTERNAL CIRCLIP PLIERS STRAIGHT 180MM	WATER PUMP PLIERS 250MM
INSIDE SPRING JOINT CALIPER 150MM LONG	PRECISION DATA BOOK METRIC



MILLWRIGHT TOOLKIT

NEEDLE FILE SET 12PCE 180MM C/W HANDLES	DIVIDER JOINT SPRING 150MM
HAMMER BP 450G WOOD HANDLE	SCRIBER DBL END 250MM
BAR TOMMY 19X450MM	PLIER TINSNIP CRV 250MM
TRUNK STEEL 660X340X260 26/660	SHIFTER MAXPOWER 450MM
HACKSAW FRAME 20 T	A/KEY 9PC 1.5-10MM STD BLK
OIL CAN FIXED&FLEX SPOUT 500ML	A/KEY 9PC 1/16-3/8 STD BLK
MINI HACKSAW FRAME	FEELER GAUGE 32BL 0.02-1.0MM
SPANNER SET INCL TOMMYBAR 7PCE	PUNCH CENTRE 5X10X140MM
PADLOCK BRASS 40MM H/D	SPANNER SET 6-24MM 18PC
WRENCH ADJ CRV 250MM	SPANNER COMBI DEEP OFFSET 26MM
PLIER CIRCLIP 180MM STR EXT	PLIER CRIMPING LUG 1.25-14MM
PLIER CIRCLIP 180MM STR INT	TOP TRONIC MULTIMETER TBM811
VICEGRIP CURVED JAW 250MM	PRICK PUNCH 100MM
PLIER COMBINATION 200MM CRV	LEVEL TORPEDO 225MM MAGNETIC
PLIER DIAG 180MM HL CR-V	VERNIER 150MM METRIC .02 GRADE
PLIER L/NOSE 200MM HL CR-V	SQUARE ENGINEERING 150MM
S/DRIVER 6PC SET CARD CRV	HAMMER S/FACE NON-RECOIL 50MM
SOCKET SET 24PCS 1/2DR	FILE FLAT 2C CUT 250MM BULK
PLIER W/PUMP 250MM CRV	FILE HR 2C CUT 250MM BULK
WRENCH PIPE 250MM	FILE 3 SQ 2C CUT 250MM BULK
WRENCH PIPE 350MM	FILE RND 2C CUT 250MM BULK
SAFETY SPECTACLES ADJUSTABLE	FILE SQ 2C CUT 250MM BULK
TAPE MEASURE R/CASE 3M X 16MM	FILE FLAT B/CUT 300MM BULK
KNIFE UTIL.RETRACT 61X19MM+6BL	BRUSH FILE 115X40MM
WIRE STRIPPER AUTOMATIC 180MM	FILE BAG CANVAS
RULE S/S 150MM X 20MM	HANDLE FILE PLASTIC 95MM MED
RULE S/S 300MM X 28MM	HANDLE FILE PLASTIC 110MM LRG



TOOLKITS

PLATER WELDER TOOLKIT

FILE FLAT 2C CUT 250MM BULK	BRUSH WIRE 4 ROW 250 WOOD HNDL
FILE HR 2C CUT 250MM BULK	WELDING HELMET MASK FLIPFRONT
FILE 3 SQ 2C CUT 250MM BULK	RULE S/S 300MM X 28MM
FILE RND 2C CUT 250MM BULK	RULE S/S 600MM X 28MM
FILE SQ 2C CUT 250MM BULK	SQUARE RAFTER 400 X 600MM
HANDLE FILE PLASTIC 95MM MED	SQUARE COMBINATION SET 300MM
FILE BAG CANVAS	DIVIDER JOINT SPRING 200MM
BRUSH FILE 115X40MM	SCRIBER DBL END 250MM
BAR TOMMY 19X450MM	PLIER TINSNIP STR H/D 250MM
TRUNK STEEL 660X340X260 26/660	PLIER TINSNIP R/HAND H/D 250MM
CURVOMARK RADIUS MARKER STD	PLIER TINSNIP L/HAND H/D 250MM
HACKSAW FRAME 20 T	SPANNER SET 6-32MM 26PC BOX
ERASER	LIGHTER FLINT
CHISEL COLD FLAT 20X200MM	GLOVE 2" GREEN LINE WEL
BEVEL SQUARE 200MM	RULE STEEL FOLDING 600MM 53R
ANGLE GRINDER 950W 115MM	APRON CHROME LEATHER
PADLOCK BRASS 40MM H/D	CALCULATOR SCIENTIFIC EL531
WRENCH ADJ CRV 250MM	PENCIL CLUTCH AND LEAD 0.7
VICEGRIP CURVED JAW 250MM	SQUARE SET 26CM 45
CHALK LINE REEL SET 3 PCE	SQUARE SET 26CM 60
SAFETY SPECTACLES ADJUSTABLE	SPAT LEATHER ADJUST
WELDING GOGGLES PVC F/FRONT	PLIER FENCING 250
LEVEL ALUMINIUM 60CM 3 VIAL	PRICK PUNCH 100MM
TAPE MEASURE R/CASE 5M X 19MM	HAMMER BP 450G WOOD HANDLE
HAMMER STONING F/G HNDL 2KG	HAMMER BP 900G WOOD HANDLE
SQUARE ENGINEERING 100MM	CURVOMARK CENTRE HEAD STANDARD
NOZZLE CLEANER	FLEXI CURVE 600MM
S/DRIVER SET BT 1734 9PCE GR	HAMMER S/FACE NON-RECOIL 50MM
RULE LINE OF CHORDS 600MM	RULE S/S 1000MM X 30MM
PLIER TINSNIP CRV 250MM	VERNIER 150MM METRIC .02 GRADE
CURVOMARK MARKER CONTOUR STD	PLIER W/PUMP 250MM CRV



RIGGER TOOLKIT

HANDLE FILE PLASTIC 110MM LRG	TAPE MEASURING STEEL 20M
BAR TOMMY 19X450MM	HAMMER COPPER 1.4KG R/HNDL
TRUNK 1TRAY&NOSLOT 650X275X275	SPANNER SET 6-32MM 26PC BOX
HACKSAW FRAME 20 T	RULE LINE OF CHORDS 600MM
CHISEL COLD FLAT 12X150MM	TAPE DIAMETER 2M, 0.63
CHISEL COLD FLAT 20X200MM	WIRE ROPE CUTTER 200MMX5MM
CHISEL COLD FLAT 25X250MM	HARD HAT WHITE
PADLOCK BRASS 40MM H/D	PLIER FENCING 250
WRENCH ADJ CRV 250MM	FILE FLAT B/CUT 300MM BULK
WRENCH ADJ CRV 300MM	FILE HR S/CUT 300MM BULK
VICEGRIP CURVED JAW 250MM	HAMMER BP 900G WOOD HANDLE
EAR PLUG PU	VERNIER 150MM METRIC .02 GRADE
GLOVES CHROME LEATHER 2.5"	S/DRIVER BT MS 10.0X250MM OR
SAFETY SPECTACLES ADJUSTABLE	S/DRIVER MECH BT 8X200MM
TAPE MEASURE R/CASE 3M X 16MM	WRENCH LBS PODGER 10X13
HAMMER STONING F/G HNDL 2KG	WRENCH LBS PODGER 17X19
KNIFE UTIL.RETRACT 61X19MM+6BL	BRUSH FILE 115X40MM
A/KEY 9PC 1.5-10MM STD BLK	PLIER CARP PINCER 200MM





CUTTING TOOLS



COMPARISON CHARTS

Comparison Chart Turning Grades

ISO	YG	Sandvic	Iscar	Kenna metal	Seco	Walter	Mitsu bishi	Kyocera	Tungaloy	Sumito-mo	Taegutec	Korloy	Dura-carb
P10	YG3010	GC4305 GC4205 GC4315 GC4215	IC8005 IC428 IC8150 IC9015	KCP05 KC9105 KCP10 KC9110	TP0501 TP0500 TP1501 TP1500	WPP01 WPP05S WPP10S	UE6105 MC6015 UE6110	CA5505 CA510 CA515 CA5515	T9105 T9115	AC8015P AC810P	TT8115	NC3010 NC3215	DC9015
P20	YG3020 YG801	GC4325 GC4225	IC8250 IC9015	KCP25 KC9125	TP2501 TP2500	WPP20S	MC6025 UE6020	CA525 CA5525	T9125	AC8025P AC820P	TT8125	NC3220 NC3225 NC3120	DC9025
P30	YG801 YG3030	GC4335 GC4235	IC8350 IC8025	KCP30 KC9140	TP3501 TP3500	WPP30S	MC6035 UE6035 VP15TF	CA530 CA5535 CR9025	T9135	AC8035P AC830P AC630M	TT5100 TT8135	NC3030 NC5330 PC3545	DC9025 DC8035
M10	YG801	GC2015 GC1105 GC1115	IC807 IC8025 IC907	KCM15 KC5510 KCU10	TS2000	WSM10S	US7020 US905 VP05RT VP10RT	CA6515 PR915 PR1025 PR1215	T6120	AC610M AC6020M AC510U	TT9215 TT5080	NC9020 PC8110	DC610
M20	YG801	GC2025 GC1115	IC808 IC8080 IC908	KCM25 KC5525 KCU25 KC5020	TT2501 TP2000 TM2000 TS2500	WMP20S WSM20S WSM21	US7020 VP20MF UP20M	CA6525 PR915 PR1125 PR1225	T6130	AC6020M AC6030M AC520U	TT9225 TT9080	PC5300 PC8115	
M30	YG3030	GC2035	IC830 IC928	KCM35 KC9240	TP3500 TM4000	WSM30S	UC735 VP15TF VP20MF	PR1125 PR1535	T6130	AC6030M AC6040M AC630M AC530U	TT9235 TT8020	NC9025 PC9030	DC8035
K05	YG1001	GC3205	IC5005	KCK05	TK1001 TK1000	WKK10S	MC5005 UC5101	CA4505 CA4010	T5101	AC405K	TT7005	NC6205	DC820 DC610
K10	YG1001	GC3210	IC5010 IC5100	KCK15	TK1001 TK1000	WKK10S	MC5015 UC5115	CA4515 CA4115	T515	AC415K	TT7310 TT7015	NC6210	
K15	YG3010	GC3215	IC8150	KCK20	TK2001 TK2000	WKK20S WKP30S	UE6110 VP15TF	CA4120	T5125	AC420K	TT6300	NC6215	

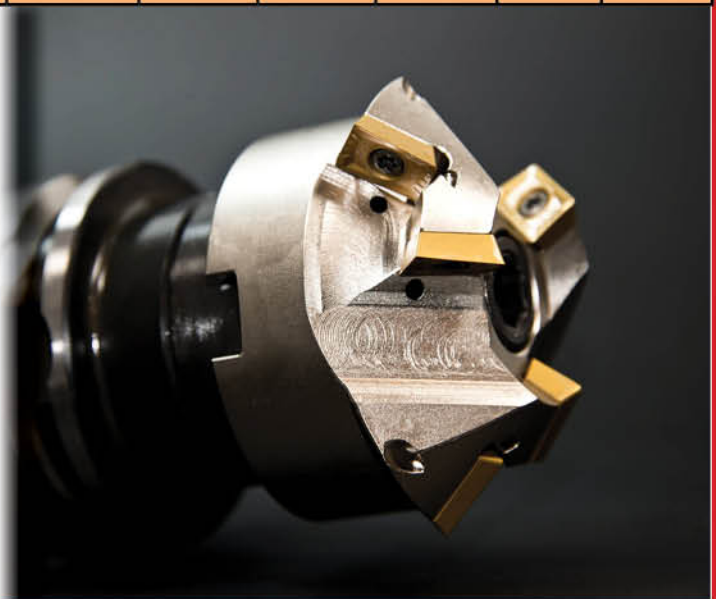

COMPARISON CHARTS

Comparison Chart

Turning Chipbreakers - Positive

ISO	YG	Sandvic	Iscar	Kenna metal	Seco	Walter	Mitsu bishi	Kyocera	Tungaloy	Sumitomo	Taegutec	Korloy	Duracarb
STEEL	UF	PF	PF	LF UF	MF2	PF2 FP4	FM LM LP	GQ PP	01 PSF	FP	FG	HFP	41
	UG	PM		MF	MF3	MP4 FP6	MP Standard MM MV	HQ	PS PM	MU	MT	C25	51
STAIN- LESS STEEL	UF	PF	PF	LF	MF2	MM4 PS5	FM LM LP	GQ PP	PM	FP	FG	HFP	41
CAST IRON	UG	PM		UF	MF3	MK4 RK4	MP Standard MM MV	HQ	CM	MU	MT	C25	51
ALUMI- NUM	AL		AS	MF	AL	PF2 PM2	AZ	CF CK	AL	AG	FL	AK	AU

Turning Chipbreakers - Negative

ISO	YG	Sand- vic	Iscar	Kenna metal	Seco	Walter	Mitsu bishi	Kyocera	Tungaloy	Sumitomo	Taegutec	Korloy	Duracarb
STEEL	UF	PF	F3P NF	FF FN	F1 MF2	FP5	FH LP	GP PP	TF	FL SP	FG FA	VF HU	41
	UL		PP NF			FP5	FY SY	CQ VF	TSF	LU	FC FT	HC	43
	UM		TF	MN	M3	MP3	MP	HS	TM	GU UX	MC PC	VM GM	46
	UG	PM	GN M3P	MN	M3 MR3	MP5	MP,MA	PS	TM	UG	MT PC	GR HR	45
	UC	PR	NR	MP RP	MR4	RP5	Standard	Standard	TH	UZ	MG-	B25	53
	UR	PR	NR R3P	UN RN MG-	MR3 MR6	RP7	RP MH RK	PT PH	THS	ME MU	RT	GR	
STAIN- LESS STEEL	MM	MM	M3M	MG-MP	MR3	NM4	MM	MS	SM	GU	EM ET	GS	42
CAST IRON	UC	PR	NR	MP RP	MR4	MK5	Standard	Standard	All Round	UZ	MG-	B25	53
	UR	PR	NR R3P	UN RN MG-	MR3 MR6	RK5 RK7	RP MH RK	PT PH	CH	ME MU	RT	GR	
	..MA			RP	MR7	..MA	MG-	C	CH	GZ	..MA		53

YG Cutting Tools

Milling Inserts

Our milling inserts range from:

- Corner - Positive
- Octagon - Positive & Negative
- Round - Positive
- Square - High feed, Positive, ISO & Negative
- Triangle - ISO

APKT 10, 16-2 Corner Positive

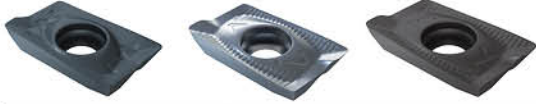

Stock code	Description
12000002	INSERT APKT160412 PDTR
12000004	APKT 100308 YG 602 INSERTS
12000005	INSERT APKT100305 PDTR
12000006	INSERT APKT160416PDTR
12000255	APKT160424PDTR-YG602
17000008	INSERT APKT160408PDTR
17000092	ALFA MILL 25D APKT16
17000093	ALFA MILL 32D APKT16
17000095	EFMILL 50D APKT16
17000096	EFMILL 63D APKT16
17000097	EFMILL 80D APKT16

ODMT - 8 Corner Positive



Stock code	Description
12000030	ODMT 0605 YG602
17000001	R/CUTTER 63D 45DEG ODMT(W)6
17000003	R/CUTTER 100D 45DEG ODMT(W)6

TPKR/N, TPUN - 3 Corner ISO



Stock code	Description
12000060	TPKR 1603 YG602
12000062	TPKN 1603 YG602
12000063	TPKN 2204 YG602
12000064	TPUN 160308 YG602

Milling Grades

YG602 - Good for Steel, Stainless Steel
Cast Iron and Super Alloy
YG200 - Good for Aluminum

YG602 (TiAlN) is a universal grade for general milling applications. With ultra dense PVD Coating for optimal thermal resistance & strength. Sub-micron substrate designed for demanding application.

YG200 (CrN) is optimized grade for Aluminum. With sub-micron substrate designed for Aluminum application coated with a unique PVD coating.

APMT 11, 16 - 2 Corner Positive



Stock code	Description
12000008	APMT 160408 YG602
12000009	APMT 113504 YG602
12000010	APMT 113508 YG602
17000102	ALFA MILL 16D APMT11
17000103	ALFA MILL 20D APMT11
17000104	ALFA MILL 25D APMT11

RDKT Round Inserts



Stock code	Description
12000034	RDKT 1204 YG602
12000041	RDKT 10T3 YG602

SPKN - 4 Corner Square ISO

SEKN - 4 Corner Square ISO

SEKT 12T3 - 4 Corner Positive



Stock code	Description
12000048	SPKN 1203 YG602
12000049	SPKN 1504 YG602 INSERT
12000054	SEKN 1203 AFTN YG602 INSERT
12000055	SEKT INSERT 1204 AFTN
12000237	SEKT1204-AL YG200

YG Cutting Tools

Turning Inserts

CNMG 80° Negative



Stock code	Description
22000001	CNMG 120408 UG YG801
22000003	CNMG 120404 UF YG801
22000099	CNMG 120408 UG YG3020
22000100	CNMG 120408 UM YG3020
22000102	CNMG 120408 UC YG3020
22000113	CNMG120408 UG YG3010
22000118	CNMG 120408 UC YG3030
22000120	CNMG 120412 UC YG3030
22000139	CNMG 120408 UG YG3030
22000140	CNMG 120408 UM YG3030
22000182	CNMG120404-UG-YG3020
22000190	CNMG 120408 UF YG3020
22000194	CNMG 120408 UL YG3030
22000196	CNMG 120408 UR YG3020
22000197	CNMG 120408 UR YG3030
22000199	CNMG120412-UG-YG3020
22000360	CNMG120408MM YG 3020
22000495	CNMG120408 MM YG213

DCMT 55° Negative



Stock code	Description
22000017	DNMG 150408 UG YG801
22000018	DNMG150604 UF YG801
22000019	DNMG 150608 UG YG801
22000090	DNMG150608 UC YG1001
22000104	DNMG 150608 UC YG3020
22000122	DNMG 150608 UC YG3030
22000229	DNMG150604-UG-YG3020
22000234	DNMG 150608 UG YG3010
22000235	DNMG 150608 UG YG3020
22000244	DNMG 150612 UG YG3020
22000245	DNMG 150612 UG YG3030
22000363	DNMG150404-UF-YG3010
22000364	DNMG150404 UF YG3020
22000367	DNMG150408 UG YG3020
22000516	DNMG150608MM YG213 INSERT

CCMT 80° Positive



Stock code	Description
22000005	CCMT120408 UG YG801
22000006	CCMT 060204 UF YG801
22000007	CCMT 09T304 UF YG801
22000008	CCMT 09T308 UG YG801
22000009	CCMT 060208 UG YG801
22000151	CCMT09T308 UG YG3020 INSERT
22000154	CCMT120408 UG 3020
22000163	CCMT060204 UF 3010
22000164	CCMT060204 UF 3020
22000170	CCMT 09T304 UF YG3020 INSERT
22000172	CCMT09T304 UG 3010
22000173	CCMT09T304 UG 3020
22000175	CCMT120404 UG 3010
22000176	CCMT120404 UG 3020
22000197	CNMG 120408 UR YG3030
22000199	CNMG120412-UG-YG3020
22000360	CNMG120408MM YG 3020
22000495	CNMG120408 MM YG213

CCMT 80° Positive



Stock code	Description
22000024	RCMT 0803 YG801
22000376	RCMT0602M0 YG3020
22000379	RCMT0803M0 YG3020
22000382	RCMT10T3M0 YG3020
22000385	RCMT1204M0 YG3020

DCMT 55° Positive



Stock code	Description
22000013	DCMT 070204 UF YG801
22000014	DCMT11T304 UF YG801
22000015	DCMT11T308 INSERT
22000211	DCMT070204 UG YG3020
22000214	DCMT 11T304 UF YG3020 INSERT

YG Cutting Tools

Turning inserts

KNUX 55° 2 Corners single side



Stock code	Description
22000079	KNUX160405 L YG801
22000080	KNUX160405 R YG801
22000250	KNUX160405L-YG3020
22000251	KNUX160405L-YG3030
22000253	KNUX160405R-YG3020
22000254	KNUX160405R YG3030

SNMG 90° Negative



Stock code	Description
22000029	SNMG 120404 UF YG801
22000030	SNMG 120408 UG YG801
22000106	SNMG 120408 YG 3020 INSERT
22000142	SNMG120408-UG-YG3020 INSERT
22000259	SNMG120412-UG-YG3020
22000657	SNMG120408 MR YG211

TNUX 60° Negative



Stock code	Description
22000289	TNUX160404R YG3020
22000292	TNUX160408R YG3020
22000413	TNUX160404 L YG3020
22000415	TNUX160408 L-YG3020

VNMG 35° Negative

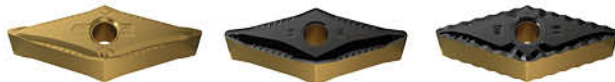

Stock code	Description
22000049	VNMG160404 UF YG801 INSERT
22000307	VNMG 160404 UF YG3020
22000313	VNMG160408 UG YG3020
22000425	VNMG160408-UC
22000431	VNMG160412 UR YG3020

DCMT 55° Positive

Stock code	Description
22000216	DCMT 11T304 UG YG3010 INSERT
22000217	DCMT11T304-UG-YG3020
22000223	DCMT11T308 INSERT UGYG3020
22000224	DCMT11T308 INSERT UGYG3030

TCMT Triangle Positive



Stock code	Description
22000032	TCMT 110204 YG801 INSERT
22000033	TCMT16T304 UF YG801 INSERT
22000034	TCMT 16T308 UG YG801
22000157	TCMT16T308 UG YG3020
22000268	TCMT16T304-UG-YG3020
22000396	TCMT110204 UF YG3020
22000398	TCMT16T304 UF YG3020

VBMT 35° Positive

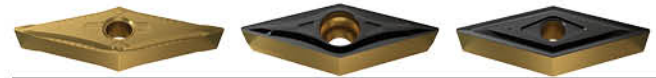

Stock code	Description
22000047	VBMT 160404 UF YG801
22000048	VBMT 160408 UF YG801
22000294	VBMT160404 YG3010
22000297	VBMT 160404 UG YG3010
22000298	VBMT 160404 UG YG3020
22000304	VBMT160408-UG-YG3020

SCMT Square Positive



Stock code	Description
22000037	TNMG 160408 UG YG801
22000038	TNMG 160412UR YG801
22000039	TNMG 160404 UF YG801
22000040	TNMG 220408 UG YG801
22000042	TNMG 220404 UF YG801
22000108	TNMG 160408 UC 3020 INSERT
22000130	TNMG160408 UC YG 3030

YG Cutting Tools

Turning inserts

WNMG 80° Trigonal Negative



Stock code	Description
22000055	WNMG 080404 UF YG801
22000056	WNMG 080408 UG YG801
22000057	WNMG 080412 UR YG801
22000059	WNMG 060408 INSERT
22000077	WNMG080408 UC YG1001
22000110	WNMG080404-UC 3020 INSERT
22000111	WNMG 080408 UC YG3020
22000112	WNMG080412 UC YG3020
22000136	WNMG 080408 UC YG3030
22000147	WNMG 080408 UG YG3010
22000148	WNMG 080408 UG YG3020
22000319	WNMG080404-UG-YG3020
22000327	WNMG 080408 UM YG3010
22000435	WNMG060404 UF 3010
22000436	WNMG060404 UF 3020
22000437	WNMG060404 UF 3030
22000438	WNMG060408 UG 3020
22000440	WNMG060408 UL YG3020
22000443	WNMG080412 UR 3020 INSERTS
22000467	WNMG080412 UR YG1001

SCMT Square Positive

Stock code	Description
22000145	TNMG 160408 UG YG3020 INSERTS
22000273	TNMG160404-UG-YG3010
22000274	TNMG160404 YG3020 INSERT
22000277	TNMG160408 UF
22000283	TNMG160408 YG3020 INSERT
22000284	TNMG160408 YG3030 INSERT
22000286	TNMG220408 UG
22000401	INSERT TNMG160404 UC YG3020
22000405	INSERT TNMG160412-UR-YG3020
22000406	INSERT TNMG160412
22000407	TNMG220404 UF YG3010
22000410	TNMG220412 YG3020

SCMT Square Positive



Stock code	Description
22000160	SCMT09T308 UG YG3020
22000256	SCMT120408 UG YG3020

Counter Sink



Stock Code	Description
C1136100	COUNTER SINK 10MM 3FL 60DEG
C1136160	COUNTER SINK 16MM 3FL 60DEG
C1136250	COUNTER SINK 25MM 3FL 60DEG
C1139063	HSS Co8 3FL CntrSink 6.3x5x45
C1139080	HSS Co8 3FL CntrSink 8x6x50
C1139100	HSS Co8 3FL CntrSink 10x6x50
C1139125	HSS Co8 3FL CntrSink 12.5X8X56
C1139160	HSS Co8 3FL CntrSink 16X10X60
C1139200	HSS Co8 3FL CntrSink 20x10x63
C1139250	HSS Co8 3FL CntrSink 25x10x67
C1139310	COUNTERSINK S/S 31MM HSS
C1186400	COUNTERSINK D-40 3FL TS HSSCo8
C1186500	COUNTERSINK D-60 3FL MT 50MM
C1189315	HSSCO8 3FL.90CSink31.5X2X112
C1189400	COUNTERSINK D-90 3FL TS HSSCo8
C1189500	TS C/SINK 50 MT#3 3FL HSSCo8
C1239S50	HSSCO8 3FL.90CSinkTINSet6.3-20

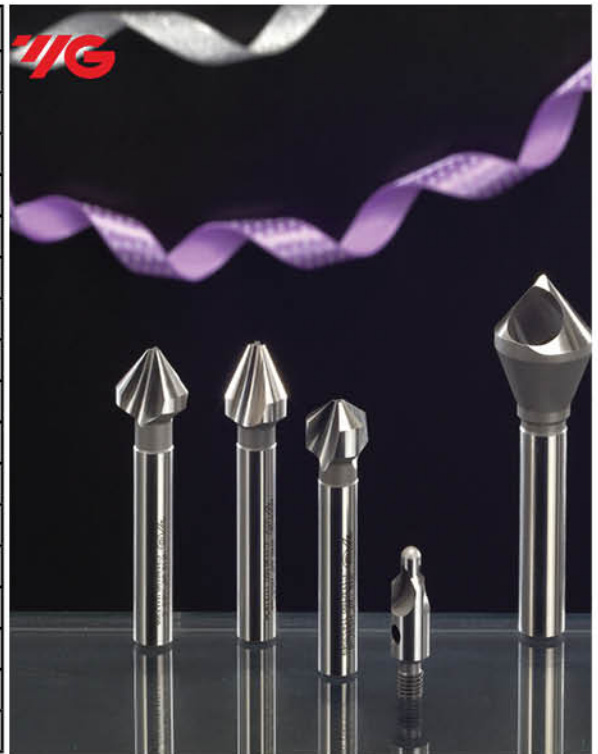

YG Cutting Tools

HSS Straight Shank Gold Plated Drills



Gold Plated Drills • 1mm - 3.3mm

Stock Code	Description
DLGP195010	Gold-P Drill Jobber 1X12X34
DLGP195011	Gold-P Drill Jobber 1.1X14X36
DLGP195012	Gold-P Drill Jobber 1.2X16X38
DLGP195013	Gold-P Drill Jobber 1.3X16X38
DLGP195014	Gold-P Drill Jobber 1.4X18X40
DLGP195015	Gold-P Drill Jobber 1.5X18X40
DLGP195016	Gold-P Drill Jobber 1.6X20X43
DLGP195017	Gold-P Drill Jobber 1.7X20X43
DLGP195018	Gold-P Drill Jobber 1.8X22X46
DLGP195019	Gold-P Drill Jobber 1.9X22X46
DLGP195020	Gold-P Drill Jobber 2X24X49
DLGP195021	Gold-P Drill Jobber 2.1X24X49
DLGP195022	Gold-P Drill Jobber 2.2X27X53
DLGP195023	Gold-P Drill Jobber 2.3X27X53
DLGP195024	Gold-P Drill Jobber 2.4X30X57
DLGP195025	Gold-P Drill Jobber 2.5X30X57
DLGP195026	Gold-P Drill Jobber 2.6X30X57
DLGP195027	Gold-P Drill Jobber 2.7X33X61
DLGP195028	Gold-P Drill Jobber 2.8X33X61
DLGP195029	Gold-P Drill Jobber 2.9X33X61
DLGP195030	Gold-P Drill Jobber 3X33X61
DLGP195031	Gold-P Drill Jobber 3.1X36X65
DLGP195032	Gold-P Drill Jobber 3.2X36X65
DLGP195033	Gold-P Drill Jobber 3.3X36X65

Gold Plated Drills • 3.4mm - 5.7mm

Stock Code	Description
DLGP195034	Gold-P Drill Jobber 3.4X39X70
DLGP195035	Gold-P Drill Jobber 3.5X39X70
DLGP195036	Gold-P Drill Jobber 3.6X39X70
DLGP195037	Gold-P Drill Jobber 3.7X39X70
DLGP195038	Gold-P Drill Jobber 3.8X43X75
DLGP195039	Gold-P Drill Jobber 3.9X43X75
DLGP195040	Gold-P Drill Jobber 4X43X75
DLGP195041	Gold-P Drill Jobber 4.1X43X75
DLGP195042	Gold-P Drill Jobber 4.2X43X75
DLGP195043	Gold-P Drill Jobber 4.3X47X80
DLGP195044	Gold-P Drill Jobber 4.4X47X80
DLGP195045	Gold-P Drill Jobber 4.5X47X80
DLGP195046	Gold-P Drill Jobber 4.6X47X80
DLGP195047	Gold-P Drill Jobber 4.7X47X80
DLGP195048	Gold-P Drill Jobber 4.8X52X86
DLGP195049	Gold-P Drill Jobber 4.9X52X86
DLGP195050	Gold-P Drill Jobber 5X52X86
DLGP195051	Gold-P Drill Jobber 5.1X52X86
DLGP195052	Gold-P Drill Jobber 5.2X52X86
DLGP195053	Gold-P Drill Jobber 5.3X52X86
DLGP195054	Gold-P Drill Jobber 5.4X57X93
DLGP195055	Gold-P Drill Jobber 5.5X57X93
DLGP195056	Gold-P Drill Jobber 5.6X57X93
DLGP195057	Gold-P Drill Jobber 5.7X57X93

YG Cutting Tools

HSS Straight Shank Gold Plated Drills

Gold Plated Drills • 5.8mm - 8.5mm	
Stock Code	Description
DLGP195058	Gold-P Drill Jobber 5.8X57X93
DLGP195059	Gold-P Drill Jobber 5.9X57X93
DLGP195060	Gold-P Drill Jobber 6X57X93
DLGP195061	Gold-P Drill Jobber 6.1X63X101
DLGP195062	Gold-P Drill Jobber 6.2X63X101
DLGP195063	Gold-P Drill Jobber 6.3X63X101
DLGP195064	Gold-P Drill Jobber 6.4X63X101
DLGP195065	Gold-P Drill Jobber 6.5X63X101
DLGP195066	Gold-P Drill Jobber 6.6X63X101
DLGP195067	Gold-P Drill Jobber 6.7X63X101
DLGP195068	Gold-P Drill Jobber 6.8X69X109
DLGP195069	Gold-P Drill Jobber 6.9X69X109
DLGP195070	Gold-P Drill Jobber 7X69X109
DLGP195071	Gold-P Drill Jobber 7.1X69X109
DLGP195072	Gold-P Drill Jobber 7.2X69X109
DLGP195073	Gold-P Drill Jobber 7.3X69X109
DLGP195074	Gold-P Drill Jobber 7.4X69X109
DLGP195075	Gold-P Drill Jobber 7.5X69X109
DLGP195076	Gold-P Drill Jobber 7.6X75X117
DLGP195077	Gold-P Drill Jobber 7.7X75X117
DLGP195078	Gold-P Drill Jobber 7.8X75X117
DLGP195079	Gold-P Drill Jobber 7.9X75X117
DLGP195080	Gold-P Drill Jobber 8X75X117
DLGP195081	Gold-P Drill Jobber 8.1X75X117
DLGP195082	Gold-P Drill Jobber 8.2X75X117
DLGP195083	Gold-P Drill Jobber 8.3X75X117
DLGP195084	Gold-P Drill Jobber 8.4X75X117
DLGP195085	Gold-P Drill Jobber 8.5X75X117

Gold Plated Drills • 8.6mm - 13mm	
Stock Code	Description
DLGP195086	Gold-P Drill Jobber 8.6X81X125
DLGP195087	Gold-P Drill Jobber 8.7X81X125
DLGP195088	Gold-P Drill Jobber 8.8X81X125
DLGP195089	Gold-P Drill Jobber 8.9X81X125
DLGP195090	Gold-P Drill Jobber 9X81X125
DLGP195091	Gold-P Drill Jobber 9.1X81X125
DLGP195092	Gold-P Drill Jobber 9.2X81X125
DLGP195093	Gold-P Drill Jobber 9.3X81X125
DLGP195094	Gold-P Drill Jobber 9.4X81X125
DLGP195095	Gold-P Drill Jobber 9.5X81X125
DLGP195096	Gold-P Drill Jobber 9.6X87X133
DLGP195097	Gold-P Drill Jobber 9.7X87X133
DLGP195098	Gold-P Drill Jobber 9.8X87X133
DLGP195099	Gold-P Drill Jobber 9.9X87X133
DLGP195100	Gold-P Drill Jobber 10X87X133
DLGP195101	Gold-P Drill Jobber 10.1X87X133
DLGP195102	Gold-P Drill Jobber 10.2X87X133
DLGP195103	Gold-P Drill Jobber 10.3X87X133
DLGP195104	Gold-P Drill Jobber 10.4X87X133
DLGP195105	Gold-P Drill Jobber 10.5X87X133
DLGP195110	Gold-P Drill Jobber 11X94X142
DLGP195115	Gold-P Drill Jobber 11.5X94X142
DLGP195120	Gold-P Drill Jobber 12X101X151
DLGP195122	Gold-P Drill Jobber 12.2X101X151
DLGP195125	Gold-P Drill Jobber 12.5X101X151
DLGP195127	Gold-P Drill Jobber 12.7X101X151
DLGP195130	Gold-P Drill Jobber 13X101X151

Also available:

- Straight Shank Twist Jobber Drills D1105 Series.
- Straight Shank Twist Stub Drills D1107 Series.
- Straight Shank Jobber Drills D1125 Series.
- Straight Shank Jobber Drills D1135 Series.
- Silver & Deming Drills D1152 Series Reduced Shank Drill.
- General Carbide Stub Drills & Jobber.
- Straight Shank Drills DL105 Series.



YG Cutting Tools

Morse Tapper Shank Drills

Also Available:

- D1208 Series Long
- Drills D1207 Series Long



Morse Tapper Shank Twist Drills Jobber D1205 Series 10mm - 27mm	
Stock Code	Description
D1205100	MT DRILL 10XMT 1X87X168
D1205105	MT DRILL 10.5X87X168
D1205110	MT DRILL 11XMT 1X94X175
D1205120	MT DRILL 12XMT 1X101X18
D1205125	12.5MM MTS DRILL
D1205130	HSSJobbMTDrill13X1X101X182
D1205135	HSSJobbMTDrill13.5X1X108X189
D1205140	HSSJobbMTDrill14X1X108X189
D1205145	HSSJobbMTDrill14.5X2X114X212
D1205150	HSSJobbMTDrill15X2X114X212
D1205155	HSSJobbMTDrill15.5X2X120X218
D1205160	HSSJobbMTDrill16X2X120X218
D1205165	HSSJobbMTDrill16.5X2X125X223
D1205170	HSSJobbMTDrill17X2X125X223
D1205175	HSSJobbMTDrill17.5X2X130X228
D1205180	HSSJobbMTDrill18X2X130X228
D1205185	HSSJobbMTDrill18.5X2X135X233
D1205190	HSSJobbMTDrill19X2X135X233
D1205195	HSSJobbMTDrill19.5X2X140X238
D1205200	HSSJobbMTDrill20X2X140X238
D1205205	HSSJobbMTDrill20.5X2X145X243
D1205210	HSSJobbMTDrill21X2X145X243
D1205215	HSSJobbMTDrill21.5X2X150X248
D1205220	HSSJobbMTDrill22X2X150X248
D1205225	HSSJobbMTDrill22.5X2X155X253
D1205230	HSSJobbMTDrill23X2X155X253
D1205235	HSSJobbMTDrill23.5X3X155X276
D1205240	HSSJobbMTDrill24X3X160X281
D1205245	HSSJobbMTDrill24.5X3X160X281
D1205250	HSSJobbMTDrill25X3X160X281
D1205255	HSSJobbMTDrill25.5X3X165X286
D1205260	HSSJobbMTDrill26X3X165X286
D1205265	HSSJobbMTDrill26.5X3X165X286
D1205270	HSSJobbMTDrill27X3X170X291

Morse Tapper Shank Twist Drills Jobber D1205 Series 27.5mm - 60mm	
Stock Code	Description
D1205275	HSSJobbMTDrill27.5X3X170X291
D1205280	HSSJobbMTDrill28X3X170X291
D1205285	HSSJobbMTDrill28.5X3X175X296
D1205290	HSSJobbMTDrill29X3X175X296
D1205295	HSSJobbMTDrill29.5X3X175X296
D1205300	HSSJobbMTDrill30X3X175X296
D1205305	HSSJobbMTDrill30.5X3X180X301
D1205310	HSSJobbMTDrill31X3X180X301
D1205315	HSSJobbMTDrill31.5X3X180X301
D1205320	HSSJobbMTDrill32X4X185X334
D1205325	HSSJobbMTDrill32.5X4X185X334
D1205330	HSSJobbMTDrill33X4X185X334
D1205335	HSSJobbMTDrill33.5X4X185X334
D1205340	HSSJobbMTDrill34X4X190X339
D1205345	HSSJobbMTDrill34.5X4X190X339
D1205350	HSSJobbMTDrill35X4X190X339
D1205355	HSSJobbMTDrill35.5X4X190X339
D1205360	HSSJobbMTDrill36X4X195X344
D1205365	HSSJobbMTDrill36.5X4X195X344
D1205370	HSSJobbMTDrill37X4X195X344
D1205375	HSSJobbMTDrill37.5X4X195X344
D1205380	HSSJobbMTDrill38X4X200X349
D1205385	HSSJobbMTDrill38.5X4X200X349
D1205390	HSSJobbMTDrill39X4X200X349
D1205395	HSSJobbMTDrill39.5X4X200X349
D1205400	HSSJobbMTDrill40X4X200X349
D1205405	40.5 MT HSS DRILL
D1205440K	MT DRILL 44MM
D1205450	45MM M-TAPER DRILL HSS
D1205480	48MM M-TAPER DRILL HSS
D1205480K	48MM M-TAPER DRILL HSS
D1205500	MT DRILL 50X220X369
D1205580	HSS JOBBER T/S DRILL 58XMT#5
D1205600	HSS JOBBER T/S DRILL 60XMT#5

YG Cutting Tools

HSS Centre Drills

- A Form.
- BS Form.
- R Form.



Centre Drills		Centre Drills	
Stock Code	Description	Stock Code	Description
D1303010	HSS CNT Drill A 1X3.15X1.3X31.5	D1363040	HSS CNT Drill R 4X10XR10X56
D1303016	HSS CNT Drill A 1.6X4X2X35.5	D1363050	HSS CNT Drill R 5X12.5XR12.5X63
D1303020	HSS CNT Drill A 2X5X2.5X40	D1363063	HSS CNT Drill R 6.3X16XR16X71
D1303025	HSS CNT Drill A 2.5X6.3X3.1X45	D1C90380	CNTR DRILL BS2 1.59X4.76X2.2X45
D1303040	HSS CNT Drill A 4X10X5X56	D1C90381	CNTR DRILL BS3 2.38X6.35X3.6X51
D1303050	HSS CNT Drill A 5X12.5X6.3X63	D1C90382	CNTR DRILL BS4 3.18X7.94X4.4X57
D1303063	HSS CNT Drill A 6.3X16X8X71	D1C90383	CNTR DRILL BS5 4.76X11.11X6.8X64
D1303080	HSS CNT Drill A 8X20X10.1X80	D1C90384	CNTR DRILL BS6 6.35X15.88X8.7X76
D1303100	HSS CNT Drill 10X25	D1C90385	CNTR DRILL BS8 7.94X19.05X11.1X89
D1303931	HSS CNT Drill A 3.15X8X3.9X50	DV334020	CNTR DRILL XL HSS 2X6X2.5X120
D1313020	CENTRE DRILL 2X8X2.5X50	DV334025	CNTR DRILL XL HSS 2.5X8X3.1X120
D1313063	CENTRE DRILL 6.3X20X8X80	DV334040	CNTR DRILL XL HSS 4X12X5X120
D1363031	HSS CNT Drill R 3.15X8XR8X50		

Drill Bit Sets

Drill sets G-Plated & Jobber	
Stock Code	Description
D1SET1004	HSS JOBBER DRILL SET 1-6MM 0.1INC
D1SET1005	HSS JOBBER DRILL SET 6-10MM 0.1INC
D1SET951	1-13MM 0.5INC JOBB DRILL SET
DLGP195SET2	DRILL SET GOLD-P 1.5-13 (0.5inc)
DLSET944	HSSCo5 JOBDrillSet1-13 0.5STEP
D1SET942	HSS JOBBER DRILL SET 1.0-13.0X0.5MM



Spot Drills

Spot Drills		Spot Drills	
Stock Code	Description	Stock Code	Description
DQ306030	HSSCo8 NC Spot Drill 3X12X46	DQ306080	HSSCo8 NC Spot Drill 8X25X79
DQ306040	HSSCo8 NC Spot Drill 4X12X55	DQ306100	HSSCo8 NC Spot Drill 10X25X89
DQ306050	HSSCo8 NC Spot Drill 5X15X60	DQ306120	HSSCo8 NC Spot Drill 12X30X102
DQ306060	HSSCo8 NC Spot Drill 6X20X66	DQ306160	HSSCo8 NC Spot Drill 16X35X115

YG Cutting Tools

HSS End Mills - General

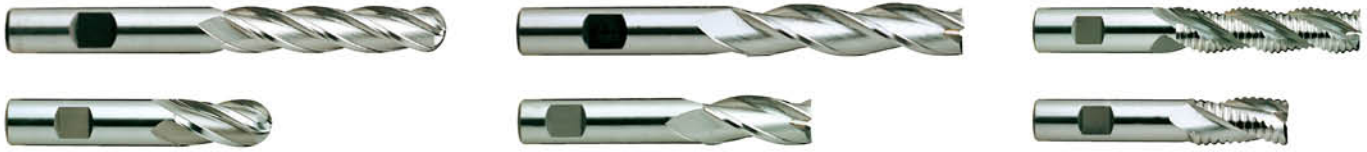

Stock Code	Description	Dimension
E2545 Series HSS Co8 4FL Helix Short 2.5mm - 20mm (Shank Type Thread)		
E2545025	HSSCo8(M42) 4FL 30deg. Helix Short E/M	2.5X6X6.5X51
E2545030	HSSCo8(M42) 4FL 30deg. Helix Short E/M	3X6X9.5X54
E2545035	HSSCo8(M42) 4FL 30deg. Helix Short E/M	3.5X6X12.5X57
E2545040	HSSCo8(M42) 4FL 30deg. Helix Short E/M	4X6X12.5X57
E2545045	HSSCo8(M42) 4FL 30deg. Helix Short E/M	4.5X6X12.5X57
E2545050	HSSCo8(M42) 4FL 30deg. Helix Short E/M	5X6X16X60.5
E2545055	HSSCo8(M42) 4FL 30deg. Helix Short E/M	5.5X6X16X60.5
E2545060	HSSCo8(M42) 4FL 30deg. Helix Short E/M	6X6X16X60.5
E2545065	HSSCo8(M42) 4FL 30deg. Helix Short E/M	6.5X10X16X60.5
E2545070	HSSCo8(M42) 4FL 30deg. Helix Short E/M	7X10X15X60.5
E2545075	HSSCo8(M42) 4FL 30deg. Helix Short E/M	7.5X10X18X63.5
E2545080	HSSCo8(M42) Multi FL 30deg. Helix Short E/M	8X10X18X63.5
E2545085	HSSCo8(M42) 4FL 30deg. Helix Short E/M	8.5X10X21X66.5
E2545090	HSSCo8(M42) 4FL 30deg. Helix Short E/M	9X10X21X66.5
E2545095	HSSCo8(M42) 4FL 30deg. Helix Short E/M	9.5X10X21X66.5
E2545100	HSSCo8(M42) Multi FL 30deg. Helix Short E/M	10X10X21X66.5
E2545100	HSSCo8(M42) Multi FL 30deg. Helix Short E/M	10X10X21X66.5
E2545105	HSSCo8(M42) 4FL 30deg. Helix Short E/M	10.5X12X19X66.5
E2545120	HSSCo8(M42) 4FL 30deg. Helix Short E/M	12X12X24X70
E2545130	HSSCo8(M42) 4FL 30deg. Helix Short E/M	13X12X24.5X70
E2545140	HSSCo8(M42) 4FL 30deg. Helix Short E/M	14X12X28.5X73
E2545150	HSSCo8(M42) 4FL 30deg. Helix Short E/M	15X16X26.5X77
E2545160	HSSCo8(M42) 4FL 30deg. Helix Short E/M	16X16X26.5X77
E2545180	HSSCo8(M42) 4FL 30deg. Helix Short E/M	18X16X35X80
E2545190	HSSCo8(M42) 4FL 30deg. Helix Short E/M	19X16X38X83.5
E2545200	HSSCo8(M42) 4FL 30deg. Helix Short E/M	20X16X38X83.5
E2545 Series HSS Co8 6FL Helix Short 22mm - 38mm (Shank Type Thread)		
E2545220	HSSCo8(M42) 6FL 30deg. Helix Short E/M	22X25X41.5X98.5
E2545240	HSSCo8(M42) 6FL 30deg. Helix Short E/M	24X25X41.5X98.5
E2545250	HSSCo8(M42) 6FL 30deg. Helix Short E/M	25X25X44.5X101.5
E2545280	HSSCo8(M42) 6FL 30deg. Helix Short E/M	28X25X46X104.5
E2545300	HSSCo8(M42) 6FL 30deg. Helix Short E/M	30X25X46X104.5
E2545320	HSSCo8(M42) 6FL 30deg. Helix Short E/M	32X25X49X108
E2545350	HSSCo8(M42) 6FL 30deg. Helix Short E/M	35X32X54X116
E2545380	HSSCo8(M42) Multi FL Short E/M	38X32X54X116
E2545 Series HSS Co8 8FL Helix Short 40mm - 50mm (Shank Type Thread)		
E2545400	HSSCo8(M42) 8FL 30deg. Helix Short E/M	40X32X55.5X117.5
E2545450	HSSCo8(M42) 8FL 30deg. Helix Short E/M	45X32X57X119
E2545500	HSSCo8(M42) 8FL 30deg. Helix Short E/M	50X32X65X127

YG Cutting Tools

HSS End Mills - General

Also Available:

Thread		Flat	
Series	Description	Series	Description
E2469	HSSCo8(M42) 3FL 30deg. Helix Short E/M	E2535	HSSCo8(M42) 2FL N30deg. Helix Short Ball E/M
E2502	HSSCo8(M42) 2FL 30deg. Helix Short E/M	E2570	HSSCo8(M42) 2FL N30deg. Helix Short E/M
E2621	HSSCo8(M42) 2FL 30deg. Helix Ball E/M	E2751	HSSCo8(M42) Multi FL 30deg. Helix Short Roughing(Coarse) E/M
E2643	HSSCo8(M42) 2FL 30deg. Helix Long E/M	E2754	HSSCo8(M42) Multi FL 30deg. Helix Short R&F(-Coarse) E/M
E2644	HSSCo8(M42) Multi FL 30deg. Helix Long E/M	E2498	HSSCo8(M42) 4FL Corner Rounding E/M
E2506	HSSCo8(M42) 4FL Corner Rounding E/M		
EQ999	HSSCo8(M42) 3FL. Helix Special Roughing(Coarse) E/M(TIAIN) RIPPER		

Plain	
Series	Description
E2500	HSSCo8(M42) 2FL N30deg. Helix Short E/M
E2999	HSSCo8(M42) 2FL N30deg. Helix Special Ball E/M
E29993	HSSCo8(M42) 4FL N30deg. Helix Special E/M

YG Cutting Tools

End Mills - Alu Power

E5522 ALU-POWER 2FL 45deg. Helix Long E/M 2mm - 16mm (Shank Type Plain)		
E5522020	ALU-POWER 2FL 45deg. Helix Long E/M	2X3X7X38
E5522030	ALU-POWER 2FL 45deg. Helix Long E/M	3X6X8X57
E5522040	ALU-POWER 2FL 45deg. Helix Long E/M	4X6X11X57
E5522050	ALU-POWER 2FL 45deg. Helix Long E/M	5X6X13X57
E5522060	ALU-POWER 2FL 45deg. Helix Long E/M	6X6X13X57
E5522080	ALU-POWER 2FL 45deg. Helix Long E/M	8X8X19X63
E5522100	ALU-POWER 2FL 45deg. Helix Long E/M	10X10X22X72
E5522120	ALU-POWER 2FL 45deg. Helix Long E/M	12X12X26X83
E5522160	ALU-POWER 2FL 45deg. Helix Long E/M	16X16X32X92
E5E47 ALU-POWER 1FL 45deg. Helix Long E/M 2mm - 16mm (Shank Type Plain)		
E5E47020	ALU PWR 1FL 45deg. Helix Long E/M	2X3X8X50
E5E47030	ALU PWR 1FL 45deg. Helix Long E/M	3X3X12X50
E5E47040	ALU PWR 1FL 45deg. Helix Long E/M	4X4X15X60
E5E47050	ALU PWR 1FL 45deg. Helix Long E/M	5X5X17X60
E5E47060	ALU PWR 1FL 45deg. Helix Long E/M	6X6X20X65
E5E47080	ALU PWR 1FL 45deg. Helix Long E/M	8X8X22X65
E5E47100	ALU PWR 1FL 45deg. Helix Long E/M	10X10X25X75
E5E47120	ALU PWR 1FL 45deg. Helix Long E/M	12X12X30X80

Also Available:

- E5E49 ALU-POWER 3FL 45deg. Helix Long E/M (Shank Type Plain)
- E5908 ALU-POWER 3FL 40deg. Helix Ball E/M (Shank Type Plain)
- E5711 ALU-POWER 3FL 30deg. Helix Long Roughing(Coarse) E/M (Shank Type Plain)



YG Cutting Tools

HSS End Mills - Counterbore

Series	Description	Dimensions
EL950	HSSCO5(M35) 3FL CB PILOT	6X5X14X71
EL950	HSSCO5(M35) 3FL CB PILOT	6.5X5X14X71
EL950	HSSCO5(M35) 3FL CB PILOT	8X5X14X71
EL950	HSSCO5(M35) 3FL CB PILOT	10X8X18X80
EL950	HSSCO5(M35) 3FL CB PILOT	11X8X18X80
EL950	HSSCO5(M35) 3FL CB PILOT	15X12.5X22X100
EL950	HSSCO5(M35) 3FL CB PILOT	18X12.5X22X100
EL950	HSSCO5(M35) 3FL CB PILOT	20X12.5X22X100
EL950	HSSCO5(M35) 3FL CB PILOT	6X5X14X71
EL950	HSSCO5(M35) 3FL CB PILOT	6.5X5X14X71
EL950	HSSCO5(M35) 3FL CB PILOT	8X5X14X71
EL950	HSSCO5(M35) 3FL CB PILOT	10X8X18X80
EL950	HSSCO5(M35) 3FL CB PILOT	11X8X18X80
EL950	HSSCO5(M35) 3FL CB PILOT	15X12.5X22X100
EL950	HSSCO5(M35) 3FL CB PILOT	18X12.5X22X100
EL950	HSSCO5(M35) 3FL CB PILOT	20X12.5X22X100



YG Cutting Tools

HSS End Mills - X Power

EM810 X-POWER 2FL 30deg. Helix Short E/M 1mm - 20mm (Shank Type Plain)

Series	Description	Dimensions
EM810	X-POWER 2FL 30deg. Helix Miniature E/M	1X4X2.5X40
EM810	X-POWER 2FL 30deg. Helix Miniature E/M	1.5X4X4X40
EM810	X-POWER 2FL 30deg. Helix Short E/M	2X4X6X40
EM810	X-POWER 2FL 30deg. Helix Short E/M	2.5X4X8X40
EM810	X-POWER 2FL 30deg. Helix Short E/M	3X6X8X45
EM810	X-POWER 2FL 30deg. Helix Short E/M	4X6X11X45
EM810	X-POWER 2FL 30deg. Helix Short E/M	5X6X13X50
EM810	X-POWER 2FL 30deg. Helix Short E/M	6X6X13X50
EM810	X-POWER 2FL 30deg. Helix Short E/M	8X8X19X60
EM810	X-POWER 2FL 30deg. Helix Short E/M	10X10X22X70
EM810	X-POWER 2FL 30deg. Helix Short E/M	12X12X26X75
EM810	X-POWER 2FL 30deg. Helix Short E/M	14X14X26X85
EM810	X-POWER 2FL 30deg. Helix Short E/M	16X16X32X100
EM810	X-POWER 2FL 30deg. Helix Short E/M	18X18X32X100
EM810	X-POWER 2FL 30deg. Helix Short E/M	20X20X38X105

Also Available:

2 Flute

- [EM816](#) XPWR 2FL L/S BN
- [EM876](#) X-POWER 2FL. Helix Short Ball E/M
- [EM813](#) XPWR 2FL L/S BN

4 Flute

- [EM811](#) X-POWER 4FL. Helix Short E/M
- [EM815](#) XPWR 4FL LONG B/N
- [EM817](#) XPWR 4FL L/S

Multi Flute

- [EM824](#) X-POWER Multi FL. Helix Long Roughing(Fine) E/M



YG Cutting Tools

HSS End Mills - K2 Carbide

G9424 K-2 Carbide 2FL Short E/M 1mm - 20mm

Series	Description	Dimensions
G9424	K-2 CARBIDE 2FL SHORT E/M	1X4X3X40
G9424	K-2 CARBIDE 2FL SHORT E/M	1.5X4X4.5X40
G9424	K-2 CARBIDE 2FL SHORT E/M	2X2X8X32
G9424	K-2 CARBIDE 2FL SHORT E/M	2.5X2.5X8X32
G9424	K-2 CARBIDE 2FL SHORT E/M	3X3X12X32
G9424	K-2 CARBIDE 2FL SHORT E/M	3.5X3.5X12X32
G9424	K-2 CARBIDE 2FL SHORT E/M	4X4X12X40
G9424	K-2 CARBIDE 2FL SHORT E/M	4.5X4.5X14X50
G9424	K-2 CARBIDE 2FL SHORT E/M	5X5X14X50
G9424	K-2 CARBIDE 2FL SHORT E/M	5.5X5.5X16X50
G9424	K-2 CARBIDE 2FL SHORT E/M	6X6X16X50
G9424	K-2 CARBIDE 2FL SHORT E/M	7X7X20X60
G9424	K-2 CARBIDE 2FL SHORT E/M	8X8X20X60
G9424	K-2 CARBIDE 2FL SHORT E/M	9X9X20X60
G9424	K-2 CARBIDE 2FL SHORT E/M	10X10X22X70
G9424	K-2 CARBIDE 2FL SHORT E/M	12X12X22X70
G9424	K-2 CARBIDE 2FL SHORT E/M	14X14X25X75
G9424	K-2 CARBIDE 2FL SHORT E/M	16X16X25X75
G9424	K-2 CARBIDE 2FL SHORT E/M	20X20X32X100

Also Available

2 Flute

- [G9452](#) K-2 CARBIDE 2FL EX-LONG E/M
- [G9454](#) K-2 CARBIDE 2FL LONG B E/M
- [G9527](#) K-2 CARBIDE 2FL N30° LONG E/M
- [G9A70](#) K-2 CARBIDE 2FL SHORT B/N E/M
- [G9B81](#) K-2 CARBIDE 2FL RIB B E/M

4 Flute

- [G9448](#) K-2 CARBIDE 4FL N30° SHORT E/M
- [G9449](#) K-2 CARBIDE 4FL N30° LONG E/M
- [G9453](#) K-2 CARBIDE 4FL EX-LONG E/M
- [G9540](#) K-2 CARBIDE 4FL N30° LONG E/M
- [G9A69](#) K-2 CARBIDE 4FL SHORT E/M

3 Flute

- [G9439](#) K-2 CARBIDE 3FL N30° SHORT E/M



YG Cutting Tools

HSS End Mills - Tank Power

GA936 TANK-POWER 2FL SHORT E/M (Shank Type Flat)

Series	Description	Dimensions
GA936	TANK-POWER 2FL SHORT E/M	1X6X2.5X47
GA936	TANK-POWER 2FL SHORT E/M	2X6X4X48
GA936	TANK-POWER 2FL SHORT E/M	3X6X5X49
GA936	TANK-POWER 2FL SHORT E/M	4X6X7X51
GA936	TANK-POWER 2FL SHORT E/M	5X6X8X52
GA936	TANK-POWER 2FL SHORT E/M	6X6X8X52
GA936	TANK-POWER 2FL SHORT E/M	7X10X10X60
GA936	TANK-POWER 2FL SHORT E/M	8X10X11X61
GA936	TANK-POWER 2FL SHORT E/M	9X10X11X61
GA936	TANK-POWER 2FL SHORT E/M	10X10X13X63
GA936	TANK-POWER 2FL SHORT E/M	12X12X16X73
GA936	TANK-POWER 2FL SHORT E/M	14X12X16X73
GA936	TANK-POWER 2FL SHORT E/M	16X16X19X79
GA936	TANK-POWER 2FL SHORT E/M	18X16X19X79
GA936	TANK-POWER 2FL SHORT E/M	20X20X22X88
GA936	TANK-POWER 2FL SHORT E/M	22X20X22X88
GA936	TANK-POWER 2FL SHORT E/M	25X25X26X102

Also Available:

- [GA938](#) TANK-POWER 4FL SHORT E/M
- [GA940](#) TANK-POWER 2FL SHORT B E/M
- [GA941](#) TANK-POWER MFL SHORT R E/M
- [GAA35](#) TANK-POWER MFL LONG R E/M



YG Cutting Tools

HSS Reamers

K1172 HSS TS SP. MACHINE REAMER			K1172 HSS TS SP. MACHINE REAMER		
Series	Description	Dimensions	Series	Description	Dimensions
K1172	HSS TS SP. MACHINE REAMER	6XMT#1X48X125	K1172	HSS TS SP. MACHINE REAMER	16XMT#2X87X187
K1172	HSS TS SP. MACHINE REAMER	8XMT#1X58X138	K1172	HSS TS SP. MACHINE REAMER	16.5XMT#2X87X187
K1172	HSS TS SP. MACHINE REAMER	8.5XMT#1X58X138	K1172	HSS TS SP. MACHINE REAMER	17XMT#2X87X187
K1172	HSS TS SP. MACHINE REAMER	9XMT#1X62X141	K1172	HSS TS SP. MACHINE REAMER	17.5XMT#2X94X194
K1172	HSS TS SP. MACHINE REAMER	9.5XMT#1X62X141	K1172	HSS TS SP. MACHINE REAMER	18XMT#2X94X194
K1172	HSS TS SP. MACHINE REAMER	10XMT#1X66X146	K1172	HSS TS SP. MACHINE REAMER	18.5XMT#2X94X194
K1172	HSS TS SP. MACHINE REAMER	10.5XMT#1X66X146	K1172	HSS TS SP. MACHINE REAMER	19XMT#2X94X194
K1172	HSS TS SP. MACHINE REAMER	11XMT#1X71X151	K1172	HSS TS SP. MACHINE REAMER	19.5XMT#2X100X200
K1172	HSS TS SP. MACHINE REAMER	11.5XMT#1X71X151	K1172	HSS TS SP. MACHINE REAMER	20XMT#2X100X200
K1172	HSS TS SP. MACHINE REAMER	12XMT#1X76X156	K1172	HSS TS SP. MACHINE REAMER	20.5XMT#2X100X200
K1172	HSS TS SP. MACHINE REAMER	12.5XMT#1X76X156	K1172	HSS TS SP. MACHINE REAMER	21XMT#2X100X200
K1172	HSS TS SP. MACHINE REAMER	13XMT#1X76X156	K1172	HSS TS SP. MACHINE REAMER	21.5XMT#2X107X207
K1172	HSS TS SP. MACHINE REAMER	13.5XMT#1X81X160	K1172	HSS TS SP. MACHINE REAMER	22XMT#2X107X207
K1172	HSS TS SP. MACHINE REAMER	14XMT#1X81X160	K1172	HSS TS SP. MACHINE REAMER	22.5XMT#2X107X207
K1172	HSS TS SP. MACHINE REAMER	14.5XMT#2X81X181	K1172	HSS TS SP. MACHINE REAMER	23XMT#2X107X207
K1172	HSS TS SP. MACHINE REAMER	15XMT#2X81X181	K1172	HSS TS SP. MACHINE REAMER	24XMT#3X115X242
K1172	HSS TS SP. MACHINE REAMER	15.5XMT#2X87X187	K1172	HSS TS SP. MACHINE REAMER	25XMT#3X115X242

YG Cutting Tools

HSS Reamers

K1172 HSS TS SP. MACHINE REAMER			K1172 HSS TS SP. MACHINE REAMER		
Series	Description	Dimensions	Series	Description	Dimensions
K1172	HSS TS SP. MACHINE REAMER	25.5XMT#3X115X242	K1172	HSS TS SP. MACHINE REAMER	40XMT#4X152X312
K1172	HSS TS SP. MACHINE REAMER	26XMT#3X115X242	K1172	HSS TS SP. MACHINE REAMER	41XMT#4X152X312
K1172	HSS TS SP. MACHINE REAMER	26.5XMT#3X115X242	K1172	HSS TS SP. MACHINE REAMER	42XMT#4X152X313
K1172	HSS TS SP. MACHINE REAMER	27XMT#3X124X251	K1172	HSS TS SP. MACHINE REAMER	43XMT#4X163X323
K1172	HSS TS SP. MACHINE REAMER	28XMT#3X124X251	K1172	HSS TS SP. MACHINE REAMER	44XMT#4X163X323
K1172	HSS TS SP. MACHINE REAMER	28.5XMT#3X124X251	K1172	HSS TS SP. MACHINE REAMER	45XMT#4X163X323
K1172	HSS TS SP. MACHINE REAMER	29XMT#3X124X251	K1172	HSS TS SP. MACHINE REAMER	46XMT#4X163X323
K1172	HSS TS SP. MACHINE REAMER	29.5XMT#3X124X251	K1172	HSS TS SP. MACHINE REAMER	47XMT#4X163X323
K1172	HSS TS SP. MACHINE REAMER	30XMT#3X124X251	K1172	HSS TS SP. MACHINE REAMER	48XMT#4X175X334
K1172	HSS TS SP. MACHINE REAMER	31XMT#3X133X260	K1172	HSS TS SP. MACHINE REAMER	49XMT#4X175X334
K1172	HSS TS SP. MACHINE REAMER	32XMT#4X133X294	K1172	HSS TS SP. MACHINE REAMER	50XMT#4X175X334
K1172	HSS TS SP. MACHINE REAMER	33XMT#4X133X294			
K1172	HSS TS SP. MACHINE REAMER	34XMT#4X142X303			
K1172	HSS TS SP. MACHINE REAMER	35XMT#4X142X303			
K1172	HSS TS SP. MACHINE REAMER	36XMT#4X142X303			
K1172	HSS TS SP. MACHINE REAMER	37XMT#4X142X303			
K1172	HSS TS SP. MACHINE REAMER	38XMT#4X152X312			
K1172	HSS TS SP. MACHINE REAMER	39XMT#4X152X312			



YG Cutting Tools

HSS Dovetail Cutters

HSSCo5(M35) 6FL, 8FL, 10FL, 12FL Dovetail Cutter Steam Homo (Flat Shank Type)		
Series	Description	Dimensions
ML142	HSSCo5(M35) 6FL Dovetail Cutter Steam Homo	16X12X6.3X60X60°
ML132	HSSCo5(M35) 6FL Dovetail Cutter Steam Homo	20X12X5X63X45°
ML142	HSSCo5(M35) 6FL Dovetail Cutter Steam Homo	20X12X8X63X60°
ML132	HSSCo5(M35) 8FL Dovetail Cutter Steam Homo	25X16X6.3X67X45°
ML142	HSSCo5(M35) 8FL Dovetail Cutter Steam Homo	25X16X10X67X60°
ML132	HSSCo5(M35) 10FL Dovetail Cutter Steam Homo	32X16X8X71X45°
ML142	HSSCo5(M35) 10FL Dovetail Cutter Steam Homo	32X16X12.5X71X60°
ML132	HSSCo5(M35) 12FL Dovetail Cutter Steam Homo	40X16X11X85X45°
ML142	HSSCo5(M35) 12FL Dovetail Cutter Steam Homo	40X25X13X85X60°

Also Available:

- ML172 HSSCo5(M35) 6FL, 8FL T-Slot Cutter Stg. Steam Homo (Flat Shank Type)
- ML212 HSSCo5(M35) 6FL, 8FL, 10FL, 12FL Dovetail Cutter Steam Homo (Thread Shank Type)
- ML262 HSSCo5(M35) 8FL Woodruff Cutter Stg. Steam Homo (Thread Shank Type)
- ML272 HSSCo5(M35) 6FL, 8FL T-Slot Cutter Stg. Steam Homo (Thread Shank Type)



YG Cutting Tools

Hand Taps

T7109 HSS DIN352 HAND TAP SET, First, Second, Bottoming
Also Available Sizes: M7X1.0 6H 56.0L - M24X3.0 6H 110.0L

Series	Description	Dimensions
T7109	HSS DIN352 HAND TAP SET	M3X0.5 6H 40.0L
T7109	HSS DIN352 HAND TAP #1	M3X0.5 40.0L
T7109	HSS DIN352 HAND TAP #2	M3X0.5 40.0L
T7109	HSS DIN352 HAND TAP #3	M3X0.5 6H 40.0L
T7109	HSS DIN352 HAND TAP SET	M3.5X0.6 6H 45.0L
T7109	HSS DIN352 HAND TAP #1	M3.5X0.6 45.0L
T7109	HSS DIN352 HAND TAP #2	M3.5X0.6 45.0L
T7109	HSS DIN352 HAND TAP #3	M3.5X0.6 6H 45.0L
T7109	HSS DIN352 HAND TAP SET	M4X0.7 6H 45.0L
T7109	HSS DIN352 HAND TAP #1	M4X0.7 45.0L
T7109	HSS DIN352 HAND TAP #2	M4X0.7 45.0L
T7109	HSS DIN352 HAND TAP #3	M4X0.7 6H 45.0L
T7109	HSS DIN352 HAND TAP SET	M4.5X0.75 6H 50.0L
T7109	HSS DIN352 HAND TAP #1	M4.5X0.75 50.0L
T7109	HSS DIN352 HAND TAP #2	M4.5X0.75 50.0L
T7109	HSS DIN352 HAND TAP #3	M4.5X0.75 6H 50.0L
T7109	HSS DIN352 HAND TAP SET	M5X0.8 6H 52.0L
T7109	HSS DIN352 HAND TAP #1	M5X0.8 52.0L
T7109	HSS DIN352 HAND TAP #2	M5X0.8 52.0L
T7109	HSS DIN352 HAND TAP #3	M5X0.8 6H 52.0L
T7109	HSS DIN352 HAND TAP SET	M6X1.0 6H 56.0L
T7109	HSS DIN352 HAND TAP #1	M6X1.0 56.0L
T7109	HSS DIN352 HAND TAP #2	M6X1.0 56.0L
T7109	HSS DIN352 HAND TAP #3	M6X1.0 6H 56.0L
T7109	HSS DIN352 HAND TAP SET	M7X1.0 6H 56.0L
T7109	HSS DIN352 HAND TAP #1	M7X1.0 56.0L
T7109	HSS DIN352 HAND TAP #2	M7X1.0 56.0L

Also Available

- [T7317](#) HSS ISO529 HAND TAP SET, First, Second and Bottoming
- [T7318](#) HSS ISO529 HAND TAP SET, First, Second and Bottoming
- [T7328](#) HSS ISO529 HAND TAP SET, First, Second and Bottoming
- [T7347](#) HSS ISO529 HAND TAP SET LEFT THREAD, First, Second and Bottoming
- [TS155](#) [T7378](#) HSS ISO529 BSPF PIPE HAND TAP 2SET, Taper, Bottoming



Spiral Point Combo Taps

Also Available

- [TB4285](#) HSS-E COMBO DIN376 SP PT TAP INOX
- [TB7445](#) HSS-E COMBO DIN376 SP FL TAP INOX
- [TB8042](#) HSS-E COMBO DIN371 SPIRAL FLUTE TAP
- [TB804SET5](#) HSS-E COMBO DIN371/376 SPIRAL F TAP SET
- [TB814](#) HSS-E COMBO DIN371 GUN POINT TAP
- [TB814SET5](#) HSS-E COMBO DIN371/376 GUN POINT TAP SET

YG Cutting Tools

Spiral Flut Taps

TC124 HSS-E DIN371 SPIRAL FLUTE TAP

Series	Description	Dimensions
TC124	HSS-E DIN371 SPIRAL FLUTE TAP	#4-48UNF 2B 56.0L
TC124	HSS-E DIN371 SPIRAL FLUTE TAP	#5-44UNF 2B 56.0L
TC124	HSS-E DIN371 SPIRAL FLUTE TAP	#6-40UNF 2B 56.0L
TC124	HSS-E DIN371 SPIRAL FLUTE TAP	#8-36UNF 2B 63.0L
TC124	HSS-E DIN371 SPIRAL FLUTE TAP	#10-32UNF 2B 70.0L
TC124	HSS-E DIN371 SPIRAL FLUTE TAP	#12-28UNF 2B 80.0L
TC124	HSS-E DIN371 SPIRAL FLUTE TAP	1/4-28UNF 2B 80.0L
TC124	HSS-E DIN371 SPIRAL FLUTE TAP	5/16-24UNF 2B 90.0L
TC124	HSS-E DIN371 SPIRAL FLUTE TAP	3/8-24UNF 2B 100.0L
TC124	HSS-E DIN374 SPIRAL FLUTE TAP	7/16-20UNF 2B 100.0L
TC124	HSS-E DIN374 SPIRAL FLUTE TAP	1/2-20UNF 2B 100.0L
TC124	HSS-E DIN374 SPIRAL FLUTE TAP	9/16-18UNF 2B 100.0L
TC124	HSS-E DIN374 SPIRAL FLUTE TAP	5/8-18UNF 2B 100.0L
TC124	HSS-E DIN374 SPIRAL FLUTE TAP	3/4-16UNF 2B 110.0L
TC124	HSS-E DIN374 SPIRAL FLUTE TAP	7/8-14UNF 2B 125.0L
TC124	HSS-E DIN374 SPIRAL FLUTE TAP	1"-12UNF 2B 140.0L

Also Available

- [TC134](#) HSS-E DIN2182 SPIRAL FLUTE TAP
- [TC144](#) HSS-E DIN371 SPIRAL FLUTE TAP
- [TC187](#) HSS-E ISO529 SPIRAL FLUTE TAP

Gun Taps

TC214 HSS-E DIN371 GUN POINT TAP

Series	Description	Dimensions
TC214	HSS-E DIN371 GUN POINT TAP	#6-32UNC 2B 56.0L
TC214	HSS-E DIN371 GUN POINT TAP	#8-32UNC 2B 63.0L
TC214	HSS-E DIN371 GUN POINT TAP	#10-24UNC 2B 70.0L
TC214	HSS-E DIN371 GUN POINT TAP	#12-24UNC 2B 80.0L
TC214	HSS-E DIN371 GUN POINT TAP	1/4-20UNC 2B 80.0L
TC214	HSS-E DIN371 GUN POINT TAP	5/16-18UNC 2B 90.0L
TC214	HSS-E DIN371 GUN POINT TAP	3/8-16UNC 2B 100.0L
TC214	HSS-E DIN376 GUN POINT TAP	7/16-14UNC 2B 100.0L
TC214	HSS-E DIN376 GUN POINT TAP	1/2-13UNC 2B 110.0L
TC214	HSS-E DIN376 GUN POINT TAP	9/16-12UNC 2B 110.0L
TC214	HSS-E DIN376 GUN POINT TAP	5/8-11UNC 2B 110.0L
TC214	HSS-E DIN376 GUN POINT TAP	3/4-10UNC 2B 125.0L
TC214	HSS-E DIN376 GUN POINT TAP	7/8-9UNC 2B 140.0L
TC214	HSS-E DIN376 GUN POINT TAP	1"-8UNC 2B 160.0L

Also Available

- TC222386 HSS-E DIN374 GUN POINT TAP
- TC224 HSS-E DIN2183 GUN POINT TAP
- TC234 HSS-E DIN371 GUN POINT TAP
- TC727 HSS-E DIN5156 GUN POINT BSP PIPE TAP



YG Cutting Tools

HSS-E Spiral Combo Taps

TC804 HSS-E COMBO DIN371 SPIRAL FLUTE TAP		
Series	Description	Dimensions
TC804	HSS-E COMBO DIN371 SPIRAL FLUTE TAP	M2X0.4 6H 45.0L
TC804	HSS-E COMBO DIN371 SPIRAL FLUTE TAP	M2.2X0.45 6H 45.0L
TC804	HSS-E COMBO DIN371 SPIRAL FLUTE TAP	M2.5X0.45 6H 50.0L
TC804	HSS-E COMBO DIN371 SPIRAL FLUTE TAP	M2.3X0.4 6H 45.0L
TC804	HSS-E COMBO DIN371 SPIRAL FLUTE TAP	M3X0.5 6H 56.0L
TC804	HSS-E COMBO DIN371 SPIRAL FLUTE TAP	M3.5X0.6 6H 56.0L
TC804	HSS-E COMBO DIN371 SPIRAL FLUTE TAP	M4X0.7 6H 63.0L
TC804	HSS-E COMBO DIN371 SPIRAL FLUTE TAP	M4.5X0.75 6H 70.0L
TC804	HSS-E COMBO DIN371 SPIRAL FLUTE TAP	M5X0.8 6H 70.0L
TC804	HSS-E COMBO DIN371 SPIRAL FLUTE TAP	M6X1.0 6H 80.0L
TC804	HSS-E COMBO DIN371 SPIRAL FLUTE TAP	M7X1.0 6H 80.0L
TC804	HSS-E COMBO DIN371 SPIRAL FLUTE TAP	M8X1.25 6H 90.0L
TC804	HSS-E COMBO DIN371 SPIRAL FLUTE TAP	M9X1.25 6H 90.0L
TC804	HSS-E COMBO DIN371 SPIRAL FLUTE TAP	M10X1.5 6H 100.0L
TC804	HSS-E COMBO DIN376 SPIRAL FLUTE TAP	M11X1.5 6H 100.0L
TC804	HSS-E COMBO DIN371 SPIRAL FLUTE TAP	M2.6X0.45 6H 50.0L
TC804	HSS-E COMBO DIN376 SPIRAL FLUTE TAP	M12X1.75 6H 110.0L
TC804	HSS-E COMBO DIN376 SPIRAL FLUTE TAP	M14X2.0 6H 110.0L
TC804	HSS-E COMBO DIN376 SPIRAL FLUTE TAP	M16X2.0 6H 110.0L
TC804	HSS-E COMBO DIN376 SPIRAL FLUTE TAP	M18X2.5 6H 125.0L
TC804	HSS-E COMBO DIN376 SPIRAL FLUTE TAP	M20X2.5 6H 140.0L
TC804	HSS-E COMBO DIN376 SPIRAL FLUTE TAP	M22X2.5 6H 140.0L
TC804	HSS-E COMBO DIN376 SPIRAL FLUTE TAP	M24X3.0 6H 160.0L
TC804	HSS-E COMBO DIN376 SPIRAL FLUTE TAP	M27X3.0 6H 160.0L
TC804	HSS-E COMBO DIN376 SPIRAL FLUTE TAP	M30X3.5 6H 180.0L
TC804SET7	HSS-E COMBO DIN371/376 SP FL TAP SET	M3-M12
TC804SET7-G	HSS-E COMBO SF TAP & GOLD-P DRILL SET	M3,M4,M5,M6,M8,M10,M12

Also Available:

- [TC814](#) HSS-E COMBO DIN371 GUN POINT TAP
- [TC937](#) HSS-E ISO529 GUN POINT TAP



Kennametal Cutting Tools



Cutting Tools

&

Turning Inserts

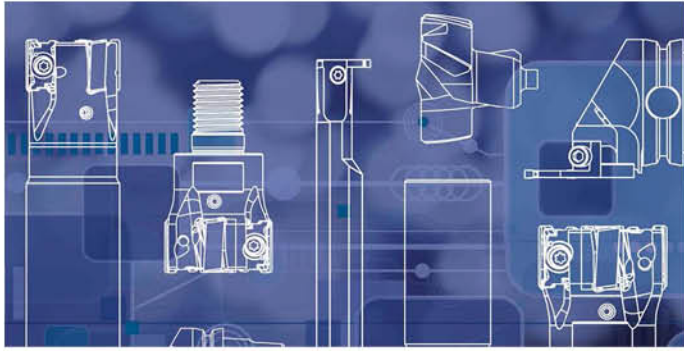
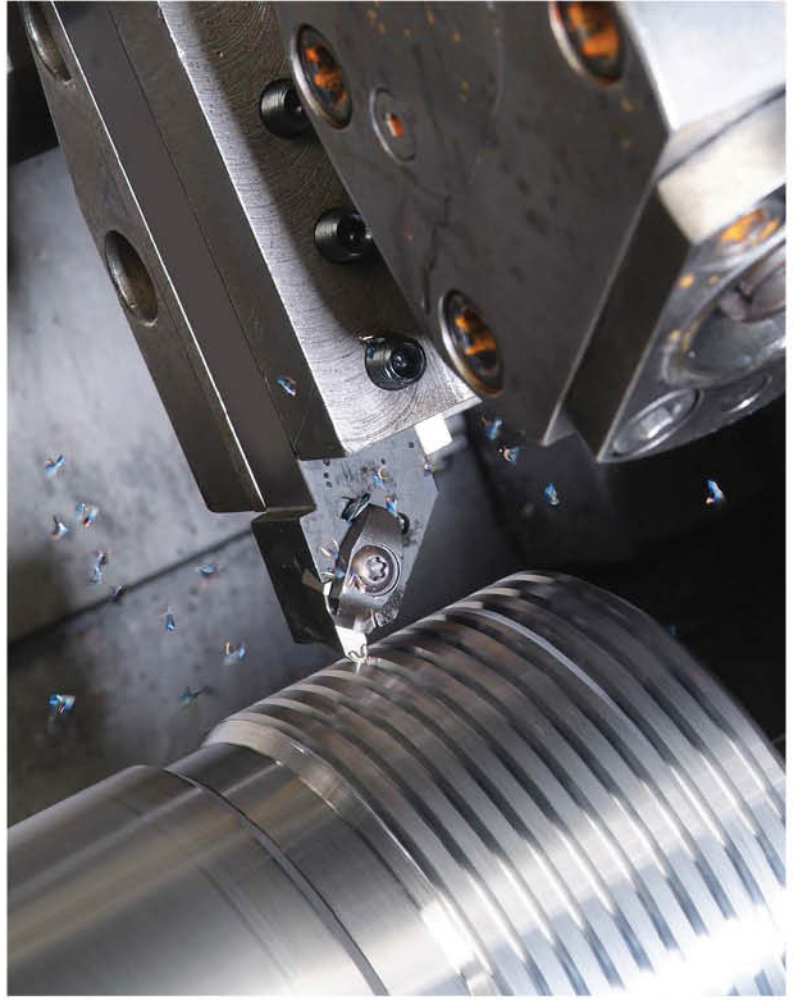



**LOCK
RANGE**

MORTICE LEVER LOCKS



- 2 LEVER LOCKS
- 3 LEVER LOCKS
- 4 LEVER LOCKS

Mortice lever locksets complete, with or without furniture

CYLINDER LOCKS



Cylinder lockset Econo DIY
Cylinder lockset Box
Cylinder lockset Euro

RIM LOCKS



Rim lock old type
Rimlock 1448/5248

TOOLS SAFE

Double Door Toolsafe 5/2



LAUN N84

SAFE LOCKS N84-1/3 MAZAK
BOLT
BRASS



LAUN N94

SAFE LOCK N94-1/3
BRASS
(HEAVY DUTY)



NIGHT LATCH LOCKS



Night Latch Double Cylinder
Night Latch Single Cylinder

GROUP 2



VIRTEX
QUALITY PRODUCTS

ABUS

Security Tech Germany

SKD

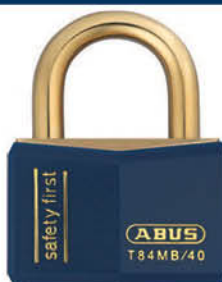

AMERICAN LOCKS

- 1- Keyed Alike
- 2- Long Shackle
- 3- Master Keyed



SKD PADLOCKS

Available in different colors

- Standard Padlock
- 40mm
 - 6mm Shackle
 - Aluminium

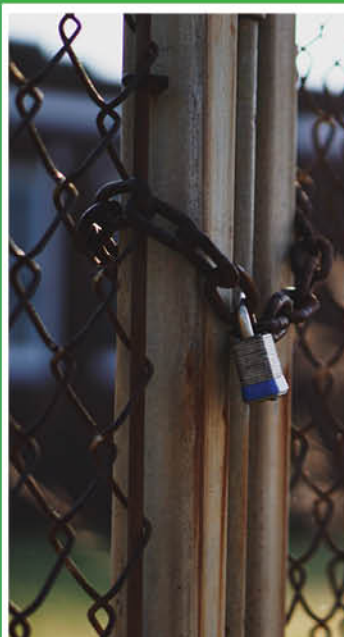

BRASS PADLOCKS



Available in:

- 20mm
- 40mm
- 50mm

ABUS LOCKS

76 SERIES SAFETY PADLOCKS



- Precision 8-pin cylinder for 250,000 guaranteed key defers.
- Many shackle options: Stainless steel, steel, steel with tubing and non-conductive plastic shackles. Also available with flexible sheathed steel cable instead of a shackle.
- Automatic locking for high comfort as well for the cable versions.
- Key retaining feature for even more security.
- Solid aluminium body: Lightweight, yet robust and long lasting.
- Plastic cover of lock body in 10 colours.

Available in various colours: Black, Blue, Brown, Green, Grey, Orange, Purple, Red, White, Yellow

CODE	DESCRIPTION	A	B	C	D	E	F	SHACKLE TYPE
76/40	40mm Safety LT8 Alu Body	40	19	38	6.5	20	90	Hardened steel with cover
76IB/40	40mm Safety LT8 Alu Body	40	20	39	5	20	89	Stainless steel without cover
76PS/40	40mm Safety LT8 Alu Body	40	20	39	5	20	89	Nylon/Plastic
76BS/40	40mm Safety LT8 Alu Body	40	20	39	5	20	89	Hardened steel without cover
76/40CAB20	40mm Safety LT8 Alu Body	40	FLEX	90 FLEX	5	20	142 FLEX	Cable 20mm
76/40CAB40	40mm Safety LT8 Alu Body	40	FLEX	190 FLEX	5	20	242 FLES	Cable 40mm
76/40HB75	40mm Safety LT8 LS 75mm	40	19	75	6.5	20	126	Hardened steel with cover
76IB/40HB75	40mm Safety LT8 LS 75mm	40	20	76	5	20	125	Stainless steel without cover
76BS/40HB75	40mm Safety LT8 LS 75mm	40	20	76	5	20	125	Hardened steel without cover

74 SERIES SAFETY PADLOCKS



- Lock body made from aluminium.
- Available with brass body.
- Inner components made from rust free materials.
- High precision 6-pin cylinder for better tamper resistance.
- Automatic locking: Locking without key by pushing down the shackle.
- Shackle made from hardened steel.
- Key retaining
- Body and shackle insulated against electric shock

Available colours: Black, Blue, Brown, Green, Grey, Orange, Purple, Red, White and Yellow

CODE	DESCRIPTION	A	B	C	D	E	F
74/40	ABUS safety padlock 40mm aluminium body	40mm	19mm	38mm	7mm	20mm	90mm
76IB/40	ABUS safety padlock 40mm aluminium body 75mm long schackle	40mm	19mm	75mm	7mm	20mm	126mm
76PS/40	ABUS safety padlock 40mm aluminium body - long body	40mm	19mm	38mm	7mm	20mm	120mm
76BS/40	ABUS safety padlock 40mm brass body	40mm	19mm	38mm	7mm	20mm	90mm
76/40CAB20	ABUS safety padlock 40mm brass body 75mm long shackle	40mm	19mm	75mm	7mm	20mm	126mm
76/40CAB40	ABUS safety padlock 40mm brass body - long body	40mm	19mm	38mm	7mm	20mm	120mm

T84 SERIES BRASS NAUTIC PADLOCKS



- Body and shackle made of solid brass.
- Plastic casing for better grip.
- Inner components made of non-corrosive materials.
- Precision pin tumbler.
- Available in a selection of colours.

CODE	DESCRIPTION	A	B	C	D	E	F	SHACKLE TYPE
T84MB/30-BLK-1	30mm brass padlock Black	32mm	14.5mm	14mm	5mm	16mm	45mm	4003318764011
T84MB/30-BLU-1	30mm brass padlock Blue	32MM	14.5mm	14mm	5mm	16mm	45mm	4003318555831
T84MB/30-GRN-1	30mm brass padlock Green	32mm	14.5mm	14mm	5mm	16mm	45mm	4003318536199
T84MB/30-RED-1	30mm brass padlock Red	32mm	14.5mm	14mm	5mm	16mm	45mm	4003318521249
T84MB/30-YEL-1	30mm brass padlock Yellow	32mm	14.5mm	14mm	5mm	16mm	45mm	4003318786648
T84MB/40-BLK-1	40mm brass padlock Black	43mm	20mm	21mm	7mm	17mm	59mm	4003318123092
T84MB/40-BLU-1	40mm brass padlock Blue	43mm	20mm	21mm	7mm	17mm	59mm	4003318532511
T84MB/40-GRN-1	40mm brass padlock Green	43mm	20mm	21mm	7mm	17mm	59mm	4003318542701
T84MB/40-RED-1	40mm brass padlock Red	43mm	20mm	21mm	7mm	17mm	59mm	4003318542718
T84MB/40-YEL-1	40mm brass padlock Yellow	43mm	20mm	21mm	7mm	17mm	59mm	4003318786723
T84MB/50-BLK-1	50mm brass padlock Black	53mm	25mm	24mm	7mm	18mm	68mm	4003318786754

ABUS LOCKS

76 SERIES SAFETY PADLOCKS



- Coloured aluminium lock body is corrosion-resistant.
 - Shackle made from hardened steel with NANO PROTECT™ coating.
 - Double-bolted with ball bearings.
 - Available key retaining.
 - ABUS precision 6-pin cylinder, can be rekeyed to match an existing key.
- Available KA, MK, GMK, and PMU**

CODE	DESCRIPTION	A	B	C	D	E	F	SHACKLE TYPE
72/40-BLK	ABUS 40mm aluminium BLK boxed	39	20	27	6.5	19	74	4003318439599
72/40-BLK-1	ABUS 40mm aluminium BLK blister	39	20	27	6.5	19	74	4003318736582
72/40-BLU	ABUS 40mm aluminium BLU boxed	39	20	27	6.5	19	74	4003318435997
72/40-BLU-1	ABUS 40mm aluminium BLU blister	39	20	27	6.5	19	74	4003318736575
72/40-BRN	ABUS 40mm aluminium BRN boxed	39	20	27	6.5	19	74	N/A
72/40-GRN	ABUS 40mm aluminium GRN boxed	39	20	27	6.5	19	74	4003318436000
72/40-GRN-1	ABUS 40mm aluminium GRN blister	39	20	27	6.5	19	74	4003318736551
72/40-GLD	ABUS 40mm aluminium GLD box	39	20	27	6.5	19	74	N/A
72/40-ONG	ABUS 40mm aluminium ONG box	39	20	27	6.5	19	74	N/A
72/40-PLE	ABUS 40mm aluminium PLE boxed	39	20	27	6.5	19	74	4003318435980
72/40-RED	ABUS 40mm aluminium RED boxed	39	20	27	6.5	19	74	4003318436024
72/40-RED-1	ABUS 40mm aluminium RED blister	39	20	27	6.5	19	74	4003318736568
72/40-YEL	ABUS 40mm aluminium YEL boxed	39	20	27	6.5	19	74	4003318436031
72/40-YEL-1	ABUS 40mm aluminium YEL blister	39	20	27	6.5	19	74	4003318772917
72/40HB40-BLK	ABUS 40mm aluminium L/S BLK box	39	20	39	6.5	19	86	4003318439605
72/40HB40-BLU	ABUS 40mm aluminium L/S BLU box	39	20	39	6.5	19	86	4003318436055
72/40HB40-GRN	ABUS 40mm aluminium L/S GRN box	39	20	39	6.5	19	86	4003318436062
72/40HB40-ONG	ABUS 40mm aluminium L/S ONG box	39	20	39	6.5	19	86	4003318436079
72/40HB40-PLE	ABUS 40mm aluminium L/S PLE box	39	20	39	6.5	19	86	4003318436048
72/40HB40-RED	ABUS 40mm aluminium L/S RED box	39	20	39	6.5	19	86	4003318436086
72/40HB40-SIL	ABUS 40mm aluminium L/S SIL box	39	20	39	6.5	19	86	4003318748035
72/40HB40-YEL	ABUS 40mm aluminium L/S YEL box	39	20	39	6.5	19	86	4003318436093



74 SERIES SAFETY PADLOCKS



- Solid lock body made from TITALIUM™ alloy: light, but secure.
- Shackle made from hardened steel with NANO PROTECT™ coating.
- Double-bolted with ball bearings.
- Patented "Z-bar" for 2-in-1 function: converts key-retaining to non-key-retaining and vice versa within seconds.
- Patented "Pinning Window" makes rekeying of the cylinder very easy.
- Cylinder can be taken out and can be rekeyed to match an existing key.
- Easy shackle change: Shackle can be exchanged within seconds.
- Various key profiles available eq. Yale, Universal, Master, Schlage etc.

83AL/40-GRN	Padlock Abus 40mm TITALIUM™ GRN	40mm	23mm	38mm	6.5	19mm	97mm	N/A
83AL/40-YEL	Padlock Abus 40mm TITALIUM™ YEL	40mm	23mm	38mm	6.5	19mm	97mm	N/A
83AL/40-RED	Padlock Abus 40mm TITALIUM™ RED	40mm	23mm	38mm	6.5	19mm	97mm	N/A
83AL/40-BLU	Padlock Abus 40mm TITALIUM™ BLU	40mm	23mm	38mm	6.5	19mm	97mm	N/A
83AL/40-BLK	Padlock Abus 40mm TITALIUM™ BLK	40mm	23mm	38mm	6.5	19mm	97mm	N/A
83AL/40-ONG	Padlock Abus 40mm TITALIUM™ ONG	40mm	23mm	38mm	6.5	19mm	97mm	N/A
83AL/40-PLE	Padlock Abus 40mm TITALIUM™ PLE	40mm	23mm	38mm	6.5	19mm	97mm	N/A
83AL/40-SIL	Padlock Abus 40mm TITALIUM™ SIL	40mm	23mm	38mm	6.5	19mm	97mm	N/A
83AL/45-GRN	Padlock Abus 45mm TITALIUM™ GRN	45mm	24mm	25mm	8mm	21mm	85mm	4003318795336
83AL/45-YEL	Padlock Abus 45mm TITALIUM™ YEL	45mm	24mm	25mm	8mm	21mm	85mm	4003318795435
83AL/45-RED	Padlock Abus 45mm TITALIUM™ RED	45mm	24mm	25mm	8mm	21mm	85mm	4003318795411
83AL/45-BLU	Padlock Abus 45mm TITALIUM™ BLU	45mm	24mm	25mm	8mm	21mm	85mm	4003318795329
83AL/45-BLK	Padlock Abus 45mm TITALIUM™ BLK	45mm	24mm	25mm	8mm	21mm	85mm	4003318795312
83AL/45-PLE	Padlock Abus 45mm TITALIUM™ PLE	45mm	24mm	25mm	8mm	21mm	85mm	4003318795404
83AL/45-ONG	Padlock Abus 45mm TITALIUM™ ONG	45mm	24mm	25mm	8mm	21mm	85mm	4003318795398
83AL/45-SIL	Padlock Abus 45mm TITALIUM™ SIL	45mm	24mm	25mm	8mm	21mm	85mm	4003318795428

GROUP 3

Safety Lockout Systems

Boxes, Tags & Valve covers

Lockout-tagout (LOTO) or lock and tag is a safety procedure which is used in industry and research settings to ensure that dangerous machines are properly shut off and not able to be started up again prior to the completion of maintenance or servicing work. It requires that hazardous energy sources be "isolated and rendered inoperative" before work is started on the equipment in question.

Lockout-tagout is used across industries as a safe method of working on hazardous equipment and is mandated by law in some countries.



Lock out Stations - Complete

CODE	DESCRIPTION
FIN1105RLOS01	Lockout Station 4 Complete
FIN1105RLOS011	Lockout Station 10 Complete
FINK1105RLOS02	Lockout Station 20-30 Complete

(Also Available with American Padlocks)

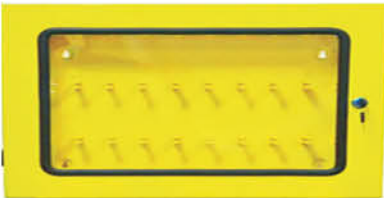

Lock out Stations - Empty

CODE	DESCRIPTION
FIN01	Lockout station 4 padlock plastic
FINS11	Lockout station 10-20 padlock plastic
FINK02	Lockout station lockable plastic
FINK03	Lockout group box kit nylon



Power plug Lockout

CODE	DESCRIPTION
P110	Power plug lockout small red 2 locking points cable size 12mm
P550	Power plug lockout large red 4 locking points cable size 25mm



Lockout safety hasp

CODE	DESCRIPTION
H770	Lockout safety hasp red 44mm plastic 6 locking points
H701	ABUS lockout safety hasp red 6 locking points
H702	ABUS lockout safety hasp red 6 locking points
H711	ABUS lockout safety hasp red 6 locking points
H712	ABUS lockout safety hasp red 6 locking points
H751	ABUS lockout safety hasp red aluminium small 6 locking points
H752	ABUS lockout safety hasp red aluminium large 6 locking points



Lockout ball valve

CODE	DESCRIPTION
V423	Ball valve lockout red 1 locking point [L] 90 [W] 52 [D] 63
V426	Ball valve lockout red 1 locking point [L] 140 [W] 125 [D] 122
V442	Ball valve lockout red 1 locking point [L] 90 [W] 52 [D] 63
V448	Ball valve lockout red 1 locking point [L] 140 [W] 125 [D] 122

LOCKOUTS



Lockout valve

CODE	DESCRIPTION
V303	Valve lockout red 1 locking pin [L] 121 [W] 80 [D] 36
V305	Valve lockout red 1 locking pin [L] 185 [W] 142 [D] 51
V307	Valve lockout red 1 locking pin [L] 225 [W] 181 [D] 61
V310	Valve lockout red 1 locking pin [L] 319 [W] 277 [D] 77
V313	Valve lockout red 1 locking pin [L] 406 [W] 364 [D] 77

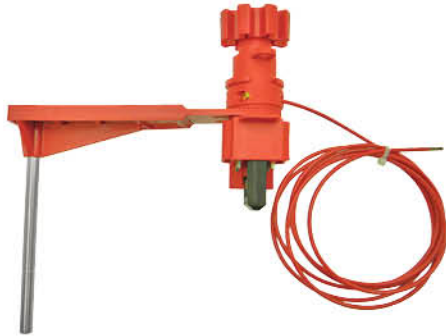

Lockout cable

CODE	DESCRIPTION
C503	Universal cable lockout 6 locking points 1000mm
C506	Universal cable lockout 6 locking points 2000mm
C509	Universal cable lockout 6 locking points 3000mm
C515	Universal cable lockout 6 locking points 5000mm
C553	Standard lockout cable length 1000mm 6 locking points
C556	Standard lockout cable length 2000mm 6 locking points
C559	Standard lockout cable length 3000mm 6 locking points
C565	Standard lockout cable length 5000mm 6 locking points



Lockouts assorted

CODE	DESCRIPTION
E202	Multipolar circuit breaker lockout red 2 locking points
E201	Circuit breaker lockout single red 1 locking point
P606	Gas cylinder lockout red 1 locking point
B835	Safety lockout REDBOX™ 12 locking points
P603	Compressed air connection lockout red 2-1 locking points

AMERL087 AMERL0873

Safety Lockout 418/419

Steel



REJECOTAG

Danger Lockout Tag
(DO NOT OPERATE)
Plastic



FINH51RED

Hasp Labeled Snap On Red
(FINH51BLU - Blue)
(FINH51YEL - Yellow)
Plastic



JLOCSJMSR40G

Padlock Safety Green
Nylon



JLOCSJMSR40R

Padlock Safety Red
Nylon



CONTACT US ON

TEL NO: +27 10 900 4500

FAX NO: +27 11 434 1594

EMAIL:sales@umqondo.com

FOR FURTHER INQUIRIES

SKD

TOOL RANGE



Our SKD products are a range of quality tested tools, all fit for use in industry.



CODE	DESCRIPTION
IS0001	MAGNETIC BASE FINE ADJUSTMENT 

CODE	DESCRIPTION
IS0011	SQUARE COMBINATION SET 300MM 

CODE	DESCRIPTION
IS0002	MICROMETER O/S 0-25MM
IS0003	MICROMETER O/S 25-50MM
IS0004	MICROMETER O/S 50-75MM
IS0005	MICROMETER O/S 75-100MM
IS0058	MICROMETER I/S 50-300MM 5 RODS 

CODE	DESCRIPTION
IS0012	GAUGE FEELER 20 BLADE .05-1MM 

CODE	DESCRIPTION
IS0006	RULE S/S 150MM X 20MM
IS0007	RULE S/S 300MM X 28MM
IS0008	RULE S/S 600MM X 28MM
IS0009	RULE S/S 1000MM X 30MM 

CODE	DESCRIPTION
IS0013	GAUGE SCREW PITCH MM 24BLD 

CODE	DESCRIPTION
IS0010	SQUARE RAFTER 400 X 600MM 

CODE	DESCRIPTION
IS0014	CALIPER I/S SPRING 100MM
IS0015	CALIPER I/S SPRING 150MM
IS0016	CALIPER I/S SPRING 200MM
IS0017	CALIPER I/S SPRING 250MM
IS0018	CALIPER O/S SPRING 100MM
IS0019	CALIPER O/S SPRING 150MM
IS0020	CALIPER O/S SPRING 200MM
IS0021	CALIPER O/S SPRING 250MM
IS0022	DIVIDER JOINT SPRING 100MM
IS0023	DIVIDER JOINT SPRING 150MM
IS0024	DIVIDER JOINT SPRING 200MM
IS0025	DIVIDER JOINT SPRING 250MM 

SKD

CODE	DESCRIPTION
IS0026	TRAMMEL HEAD 

CODE	DESCRIPTION
IS0027	SCRIBER DBL END 250MM 

CODE	DESCRIPTION
IS0028	PUNCH HOLLOW SET 2-25MM 

CODE	DESCRIPTION
IS0029	DEAD CENTRE TAPER MT5 45X200MM 

CODE	DESCRIPTION
IS0030	VERNIER DIGITAL 150MM 

CODE	DESCRIPTION
IS0048	WRENCH ADJ CRV 100MM
IS0031	WRENCH ADJ CRV 150MM
IS0032	WRENCH ADJ CRV 200MM
IS0033	WRENCH ADJ CRV 250MM
IS0034	WRENCH ADJ CRV 300MM
IS0050	WRENCH ADJ CRV 375MM
IS0051	WRENCH ADJ CRV 450MM
IS0049	WRENCH ADJ CRV 600MM 

CODE	DESCRIPTION
IS0035	WRENCH PIPE 150MM
IS0036	WRENCH PIPE 200MM
IS0037	WRENCH PIPE 250MM
IS0038	WRENCH PIPE 300MM
IS0039	WRENCH PIPE 350MM
IS0040	WRENCH PIPE 450MM
IS0041	WRENCH PIPE 600MM 

CODE	DESCRIPTION
IS0042	PLIER TINSNIP CRV 200MM
IS0043	PLIER TINSNIP CRV 250MM
IS0044	PLIER TINSNIP CRV 300MM 

CODE	DESCRIPTION
IS0045	PLIER TINSNIP STR H/D 250MM
IS0046	PLIER TINSNIP R/HAND H/D 250MM
IS0047	PLIER TINSNIP L/HAND H/D 250MM 

CODE	DESCRIPTION
IS0052	TAP WRENCH M1-M10 NO.1
IS0053	TAP WRENCH M5-M20 NO.3
IS0054	TAP WRENCH M9-M27 NO.4 

CODE	DESCRIPTION
IS0059	MICROMETER SET O/S 0-300MM 

SKD

CODE	DESCRIPTION	CODE	DESCRIPTION
IS0055	GUAGE DEPTH DIG 0-200MM	IS0103	TURN TOOL CRANK 25/25 RH 45°CI
IS0056	GUAGE DEPTH DIG 0-300MM	IS0104	RECESSING TOOL D 10/10 RH STL
IS0057	EDGE FINDER 12/5	IS0105	RECESSING TOOL D 12/12 RH STL
IS0060	TOOLBITS SQ HSS 6/63	IS0106	RECESSING TOOL D 16/16 RH STL
IS0061	TOOLBITS SQ HSS 6/100	IS0107	RECESSING TOOL D 20/20 RH STL
IS0062	TOOLBITS SQ HSS 6/160	IS0108	RECESSING TOOL D 25/25 RH STL
IS0063	TOOLBITS SQ HSS 8/63	IS0109	KNIFE CRANK TOOL B 10/10 RHSTL
IS0064	TOOLBITS SQ HSS 8/100	IS0110	KNIFE CRANK TOOL B 12/12 RHSTL
IS0065	TOOLBITS SQ HSS 8/160	IS0111	KNIFE CRANK TOOL B 16/16 RHSTL
IS0066	TOOLBITS SQ HSS 10/100	IS0112	KNIFE CRANK TOOL B 20/20 RHSTL
IS0067	TOOLBITS SQ HSS 10/160	IS0113	KNIFE CRANK TOOL B 25/25 RHSTL
IS0068	TOOLBITS SQ HSS 10/200	IS0114	KNIFE CRANK TOOL B 10/10 LHSTL
IS0069	TOOLBITS SQ HSS 12/100	IS0115	KNIFE CRANK TOOL B 12/12 LHSTL
IS0070	TOOLBITS SQ HSS 12/160	IS0116	KNIFE CRANK TOOL B 16/16 LHSTL
IS0071	TOOLBITS SQ HSS 12/200	IS0117	KNIFE CRANK TOOL B 20/20 LHSTL
IS0072	TOOLBITS SQ HSS 16/100	IS0118	KNIFE CRANK TOOL B 25/25 LHSTL
IS0073	TOOLBITS SQ HSS 16/160	IS0119	KNIFE CRANK TOOL B 10/10 RH CI
IS0074	TOOLBITS SQ HSS 16/200	IS0120	KNIFE CRANK TOOL B 12/12 RH CI
IS0075	CLOCK FINGER RES 0.01 TRVL .08	IS0121	KNIFE CRANK TOOL B 16/16 RH CI
IS0076	CALIPER DIAL .02 GRADE 0-150	IS0122	KNIFE CRANK TOOL B 20/20 RH CI
IS0077	CALIPER DIAL .02 GRADE 0-300	IS0123	KNIFE CRANK TOOL B 25/25 RH CI
IS0078	CALIPER ELEC DIG 200	IS0124	PARTING TOOL H 10/10 RH STL
IS0079	TURN TOOL BRAZ 10/10 RH 75°STL	IS0125	PARTING TOOL H 12/12 RH STL
IS0080	TURN TOOL BRAZ 12/12 RH 75°STL	IS0126	PARTING TOOL H 16/16 RH STL
IS0081	TURN TOOL BRAZ 16/16 RH 75°STL	IS0127	PARTING TOOL H 25/25 RH STL
IS0082	TURN TOOL BRAZ 20/20 RH 75°STL	IS0128	PARTING TOOL H 10/10 RH CI
IS0083	TURN TOOL BRAZ 25/25 RH 75°STL	IS0129	PARTING TOOL H 12/12 RH CI
IS0084	TURN TOOL BRAZ 10/10 LH 75°STL	IS0130	PARTING TOOL H 16/16 RH CI
IS0085	TURN TOOL BRAZ 12/12 LH 75°STL	IS0131	PARTING TOOL H 25/25 RH CI
IS0086	TURN TOOL BRAZ 16/16 LH 75°STL	IS0132	BORING BAR INT P 10/10 RH STL
IS0087	TURN TOOL BRAZ 20/20 LH 75°STL	IS0133	BORING BAR INT P 12/12 RH STL
IS0088	TURN TOOL BRAZ 25/25 LH 75°STL	IS0134	BORING BAR INT P 16/16 RH STL
IS0089	TURN TOOL CRANK 10/10 RH45°STL	IS0135	BORING BAR INT P 20/20 RH STL
IS0090	TURN TOOL CRANK 12/12 RH45°STL	IS0136	BORING BAR INT P 25/25 RH STL
IS0091	TURN TOOL CRANK 16/16 RH45°STL	IS0137	BORING BAR INT P 10/10 RH CI
IS0092	TURN TOOL CRANK 20/20 RH45°STL	IS0138	BORING BAR INT P 12/12 RH CI
IS0093	TURN TOOL CRANK 25/25 RH45°STL	IS0139	BORING BAR INT P 16/16 RH CI
IS0094	TURN TOOL CRANK 10/10 LH45°STL	IS0140	BORING BAR INT P 20/20 RH CI
IS0095	TURN TOOL CRANK 12/12 LH45°STL	IS0141	BORING BAR INT P 25/25 RH CI
IS0096	TURN TOOL CRANK 16/16 LH45°STL	IS0142	CHAMFERING TOOL F 16/10 N STL
IS0097	TURN TOOL CRANK 20/20 LH45°STL	IS0143	CHAMFERING TOOL F 20/12 N STL
IS0098	TURN TOOL CRANK 25/25 LH45°STL	IS0144	CHAMFERING TOOL F 25/16 N STL
IS0099	TURN TOOL CRANK 10/10 RH 45°CI	IS0145	CHAMFERING TOOL F 10/10 STL
IS0100	TURN TOOL CRANK 12/12 RH 45°CI	IS0146	CHAMFERING TOOL F 12/12 STL
IS0101	TURN TOOL CRANK 16/16 RH 45°CI	IS0147	CENTRE PUNCH 5X8X100MM
IS0102	TURN TOOL CRANK 20/20 RH 45°CI	IS0148	HAMMER B/PEIN 220G 290MM F/G HNDL

SANDO

UNBREAKABLE™ STRIKING TOOLS

HAMMER RANGE



Sando Hammers

Sando hammers provide Safety, Reliability & Efficiency

Forged Head & High Visibility

- Superior grain structure.
- Striking faces hardened to 50 - 58 HRC.
- Instant identification.

Positive Locking Plate

- Head will not separate from the handle.

Thickened Boss

- Further protects the hammer against overstrikes.

Ergonomic Shape & Non-Slip Grip

- Handle is shaped to provide a comfortable and safe grip.
- Secure grip in both wet and dry conditions.

High Tensile Steel Rods & Impact-Absorbing Handle

- High strength rubber-to-metal bonding makes the handle **unbreakable**.
- Heavy duty rubber cushions impact, reducing fatigue and injury.

SANDO











UNBREAKABLE™ STRIKING TOOLS



Sando Hammers

STOCK CODE	DESCRIPTION	IMAGE
JL11001	AXE 975G POLY HANDLE 445MM	
JL11002	AXE FELLING 2275G POLY HANDLE	
JL120AXE	AXE HATCHET 1.1KG R/HNDL	
JL140AXE	AXE FELLING 1.8KG R/HNDL	
JL700CL	HAMMER CLAW 700GR R/HNDL	

Sando Hammers

STOCK CODE	DESCRIPTION	IMAGE
JL1400COPCOMP	HAMMER COPPER 1.4KG R/HNDL	
JL1800COPSL	HAMMER COPPER 1.8KG R/HNDL	
JL3600COPSL	HAMMER COPPER 3.6KG R/HNDL	
JL6300COPSL	HAMMER COPPER 6.3KG R/HNDL	
JL1100DR	HAMMER CLUB 1.1KG R/HNDL	
JL1800CB	HAMMER CLUB 1.8KG R/HNDL	
JL1800SLL	HAMMER CLUB 1.8KG R/HNDL 400MM	
JL3600SL	HAMMER SLEDGE 3.6KG R/HNDL	
JL6300SL	HAMMER SLEDGE 6.3KG R/HNDL	
JL1800DR	HAMMER DRILL 1.8KG R/HNDL	

Sando Hammers

STOCK CODE	DESCRIPTION	IMAGE
JL700BP	HAMMER BALL PEN 700GR R/HNDL	
JL900BP	HAMMER BALL PEN 900GR R/HNDL	
JL1100BP	HAMMER BALL PEN 1.1 KG R/HNDL	
JL1600CP	HAMMER CROSS PEIN 1.6KG R/HNDL	
JL1800PH	HAMMER CLUB 1.8KG POLY HNDL	
JL3600PH	HAMMER CLUB 3.6KG POLY HNDL	
JL6300PH	HAMMER CLUB 6.3KG POLY HNDL	
SFH3201	HAMMER S/F NYLON/COPPER 32MM	

incco

PROFESSIONAL TOOLS MADE AFFORDABLE



P20S Range

Code	Description
INGCO-CDLI20021	 <p>Voltage:20V No-load speed:0-400/0-1500/min Max.torque:45NM Chuck capacity:0.8-10mm Torque settings:15+1 Auto-lock keyless chuck Mechanical 2-speed gear Spindle lock function 20V Lithium-Ion 2.0Ah batteries With 1pcs battery pack With 1pc 1Hr fast charger Charge volts:110V-240V~50/60Hz Integrated work light LED battery power indicator Packed by color box</p>

Code	Description
INGCO-CIDLI2002	 <p>Voltage:20V No-load speed:0-400/0-1500/min Max.impact rate:22500/min Max.torque:45NM Chuck capacity:0.85-10mm Torque settings:18+1+1 Auto-lock keyless chuck Mechanical 2-speed gear Spindle lock function 20V Lithium-Ion 2.0Ah batteries With 2pcs battery pack With 1pc 1Hr charger Charge volts:110V-240V~50/60Hz Integrated work light LED battery power indicator With 50pcs accessories Packed by canvas bag</p>

Code	Description
INGCO-FBLI2001	 <p>Volts:20V Lithium-Ion 2.0Ah battery LED battery power indicator One battery fits all INGCO 20V multiple tools Packed by color box</p>

Code	Description
INGCO-FCLI2001	 <p>Rated Input voltage:110V-240V~50/60Hz Output voltage:20V Charge current:2A Rated Input power:50W Charges 20V 2.0Ah battery in 1Hr Packed by color box</p>

Code	Description
INGCO-CRHLI1601	 <p>Voltage:20V No-load speed:0-900/min Impact rate:0-5100bpm Single impact force:1.5J Max drilling capacity:Φ16 in concrete Integrated work light With 3pcs SDS-plus drills NO battery and charger included Packed by color box</p>

Code	Description
INGCO-CSLI1501	 <p>Voltage:20V No-load speed:3600rpm Blade diameter:150mm Cutting capacity: 45° degree:33mm 90° degree:45mm Adjustable cutting depth Adjustable bevel cutting With 1pcs 150mm blade NO battery and charger included Packed by color box</p>

Code	Description
INGCO-CJSLI8501	 <p>Voltage:20V No-load speed:2600rpm Cutting capacity: Metal:8mm Wood:80mm With 5pcs blade NO battery and charger included Packed by color box</p>

Code	Description
INGCO-CABLI2001	 <p>Voltage:20V No-load speed:10000/12500/18000/min Max.air volume:2.5m3/min With 1pcs dust bag NO battery and charger included Packed by color box</p>

Ingco

P20S Range

Code	Description
INGCO-CACLI2002	<p>Voltage:20V Max.pressure:160PSI/11BAR With 3PCS LED light Digital display Automatic stop at the specified pressure Powered by vehicle or by Lithium-Ion battery With 1PCS ball adaptor With 1PCS tire valve adaptor With 1PCS air bed adaptor NO battery and charger included Packed by color box</p>



Code	Description
INGCO-CWLI2001	<p>Voltage:20V LED power dissipation:3.2W Lumens:225 NO battery and charger included Packed by double blister</p>



Code	Description
INGCO-CWLI2002	<p>Voltage:20V LED power dissipation:20W Lumens: Max:1500 Low:750 NO battery and charger included Packed by color box</p>



Code	Description
INGCO-CIWI20010	<p>Brushless Motor Voltage:20V Square Drive:1/2" No-load speed:0-1300/0-2300/min Impcat rate:0-2000/0-3300bpm Max.torque:300NM Integrated work light LED battery power indicator With 3pcs sockets(17 19 21mm) NO battery and charger included Packed by color box</p>



Code	Description
INGCO-CIRLI20020	<p>Brushless Motor Drill voltage:20V Hex shank:1/4" No-load speed:0-1300/0-2300/min Impcat rate:0-2000/0-3300bpm Max.torque:200NM Integrated work light LED battery power indicator With 2pcs screwdriver bits With 3pcs nut setters NO battery and charger included Packed by color box</p>



Code	Description
INGCO-CAGLI1151	<p>Voltage:20V No-load speed:8500/min Disc diameter:115mm Spindle thread:M14 NO battery and charger included Packed by color box</p>



Cutting Blades

Code	Description
INGCO-DMD031151HT	<p>115(4-1/2")X22.2mm Blade width:8mm Metal base thickness:0.8mm Universal purpose:ceramic,tile,marble,brick Forbidden to use for Vitrified brick (nano glass) With flange plate Packed by double blister</p>



Code	Description
INGCO-TSB111555	<p>115mm(4-1/2"),40T Arbor:22.2mm Reduction ring:16mm Suitable for angle Grinder Wood Cutting Packed by colour box</p>



Power Tools

Code	Description
INGCO-ID8508	Voltage: 220-240V~50/60Hz Input power: 850W No-load speed: 0-2700rpm Max.drilling capacity: 13mm Variable speed Froward/Reverse switch Hammer function Packed by colour box



Code	Description
INGCO-ID8508-2	Voltage: 220-240V~50/60Hz Input power: 850W No-load speed: 0-2700rpm Chuck capacity: 2-13mm Keyless chuck Variable speed Froward/Reverse switch Hammer function Packed by colour box



Code	Description
INGCO-AG8508	Voltage: 220-240V~50/60Hz Input power: 950W No-load speed: 11000rpm Disc diameter: 115mm Spindle thread: M14 With 1pcs auxiliary handle Packed by colour box



Code	Description
INGCO-AG8528	Voltage: 220-240V~50/60Hz Input power: 950W No-load speed: 11000rpm Disc diameter: 125mm Spindle thread: M14 With 1pcs auxiliary handle Packed by colour box



Code	Description
INGCO-AG10508	Voltage: 220-240V~50/60Hz Input Power: 1050W No-Load speed: 11000rpm Disc diameter: 125mm Spindle thread: M14 With 1pcs auxiliary handle Packed by colour box



Code	Description
INGCO-AG24008	Voltage:220-240V~50/60Hz Input power:2400W No-load speed:6300rpm Disc diameter:230mm Spindle thread:M14 With 1pcs auxiliary handle With 1set carbon brushes Packed by colour box



Auto Accessories & Air

Code	Description
INGCO-HBTCP2001	Current: 200AMP Clamp size: 14x9cm Suitable for emission ≤1.8L car Cable material :copper coated Cable outside diameter:8mm Cable length :2.5m Packed by zipper bag



Code	Description
INGCO-HBTCP6001	Current: 600AMP Clamp size :18x10cm Suitable for emission ≤4.5L car Cable material :copper coated Cable outside diameter:10mm Cable length :3m Packed by zipper bag



Code	Description
INGCO-AWG1001	Nozzle size:215mm Washing capacity:0.75LOperation pres- sure:4bar Packed by colour box



Code	Description
INGCO-AIW12562	Square drive:12.5mm(1/2") No-load speed:7000 rpm Max.torque:610Nm(450ft) Twin hammer mechanism Air Consumption:142.5l/min(5.0cfm) Air Pressure:6.2bar(90psi) Length:187mm(7.3") Weight:2.6kgs(5.7lbs) Air Inlet:1/4" Air hose:3/8" Packed by colour box With 3 pcs socket (17mm,19m- m,21mm)



Air & Power Tool Accessories

Code	Description
	Square drive:19mm(3/4") No-load speed:4000 rpm Max.torque:1600Nm(1180ft) Twin hammer mechanism Air Consumption:256l/min(9cfm) Air Pressure:6.2bar(90psi) Length:234mm(9.2") Weight:5.9kgs(13lbs) Air Inlet:3/8" Air hose:1/2" Packed by color box

Code	Description
	Square drive:25mm(1") No-load speed:4000 rpm Max.torque:1800Nm(1328ft) Twin hammer mechanism Air Consumption:256l/min(9cfm) Air Pressure:6.2bar(90psi) Length:234mm(9.2") Weight:5.9kgs(13lbs) Air Inlet:3/8" Air hose:1/2" Packed by colour box

Code	Description
	Square drive:25mm(1") No-load speed:3600 rpm Max.torque:3100Nm(2300ft) Air Consumption:1019l min (36cfm) Anvil:200mm(8") Capacity bolt Size:45mm(1-3/4") Air inlet:1/2" Air hose:1/2" Packed by BMC

Code	Description
	13mm keyless chuck Chuck capacity:2-13mm Connection size:1/2"-20UNF Packed by colour box

Code	Description
	Key for 13mm key chuck Length:80mm Packed by sliding card

Code	Description
	Key for 16mm key chuck Length:150mm Packed by sliding card

Also Available: SDS Plus Drill Bits Masonry

Size (mm)	Length (mm)	Size (mm)	Length (mm)	Size (mm)	Length (mm)	Size (mm)	Length (mm)	Size (mm)	Length (mm)
6	110	16	160	8	260	10	310	12	450
8	110	6	210	10	260	12	310	14	450
6	160	8	210	12	260	14	310	16	450
7	160	10	210	14	260	16	310	18	450
8	160	12	210	16	260	18	310	20	450
10	110	14	210	22	260	20	310	22	450
10	160	16	210	24	260	22	310	24	450
12	160	18	210	26	260	24	310	12	600
14	160	20	210	6	310	8	450	16	600
14	260	6	260	8	310	10	450	25	600



Hammers

Code	Description
INGCO-HCH8816	INGCO Style Handle All steel drop-forged claw hammer Heat treatment 16oz/450g Packed by paper card



Code	Description
INGCO-HCH0820	INGCO Style Handle All steel drop-forged claw hammer Heat treatment 20oz/560g Packed by paper card



Code	Description
INGCO-HRUH8216	Weight:16oz/450g INGCO Style Fiberglass handle



Code	Description
INGCO-HRUH8308	Weight:8oz/220g45% Natural rubber, Soft Type INGCO Style Fiberglass handle



Code	Description
INGCO-HRUH8316	Weight:16oz/450g45% Natural rubber,Soft TypeINGCO Style Fiberglass handle



Code	Description
INGCO-HRPH8140	Hammer diameter:40mmINGCO Style Fiberglass handle



Pliers & Grips

Code	Description
INGCO-HCP28168	Size:6"/160mmCr-V,black finish and polish TPR two colour handle Packed by PP hanger



Code	Description
INGCO-HCP28188	Size:7"/180mmCr-V,black finish and polish TPR two colour handle Packed by PP hanger



Code	Description
INGCO-HCP28208	Size:8"/200mmCr-V,black finish and polish TPR two colour handle Packed by PP hanger



Code	Description
INGCO-HDCP28168	Size:6"/160mmCr-V,black finish and polish TPR two colour handle Packed by PP hanger



Code	Description
INGCO-HDCP28188	Size:7"/180mmCr-V,black finish and polish TPR two colour handle Packed by PP hanger



Code	Description
INGCO-HHDCP28188	Size:7"/180mmCr-V,black finish and polishTPR two colour handle Packed by PP hanger



Pliers & Grips

Code	Description
NGCO-HLNP28168	Size:6"/160mmCr-V,black finish and polish TPR two colour handle Packed by PP hanger
	

Code	Description
INGCO-HBNP28168	Size:6"/160mmCr-V,black finish and polish TPR two colour handle Packed by PP hanger
	

Code	Description
INGCO-HHCP28180	Size:7"/180mmCr-V,black finish and polish TPR two colour handle Saving 30% strength than normal pliers Packed by PP hanger
	

Code	Description
INGCO-HHCP28200	Size:8"/200mmCr-V,black finish and polish TPR two colour handle Saving 30% strength than normal pliers Packed by PP hanger
	

Code	Description
INGCO-HHCP28240	Size:9.5"/240mmCr-V,black finish and polish TPR two colour handle Saving 30% strength than normal pliers Packed by PP hanger
	

Code	Description
INGCO-HHLDPC28160	Size:6"/160mmCr-V,black finish and polish TPR two colour handle Saving 30% strength than normal pliers Packed by PP hanger
	

Code	Description
INGCO-HHLDPC28180	Size:7"/180mmCr-V,black finish and polish TPR two colour handle Saving 30% strength than normal pliers Packed by PP hanger
	

Code	Description
INGCO-HHHDCP28180	Size:7"/180mmCr-V,black finish and polish TPR two colour handle Saving 30% strength than normal pliers Packed by PP hanger
	

Pliers & Grips

Code	Description
INGCO-HHLNP28160	Size:6"/160mmCr-V,black finish and polish TPR two colour handle Saving 30% strength than normal pliers Packed by PP hanger
	

Code	Description
INGCO-HHLNP28200	Size:8"/200mmCr-V,black finish and polish TPR two colour handle Saving 30% strength than normal pliers Packed by PP hanger
	

Code	Description
INGCO-HRP02230	Size:9"/228mm Cr-V,black finish and polish With plastic handle- Packed by PP hanger
	

Code	Description
INGCO-HRP02250	Size:10"/250mm Cr-V,black finish and polish With plastic handle- Packed by PP hanger
	

Code	Description
INGCO-HWSP04	Size:180mm/7" Blade material:65MnZinc alloy pack by double blister
	

Code	Description
INGCO-HWSP101	Size:10"/250mm with sharp edge for cutting wire With push down wire function With wire stripping function Can strip Six kinds of wire size Can cut five kinds of copper
	

Code	Description
INGCO-HCCP011801	Straight head circlip Plier External circlip plier Size:7"/180mm Diameter of the head:1.8mm Carbon steel Packed by PP hanger
	

Code	Description
INGCO-HCCP011751	Bent head circlip Plier External circlip plier Size:7"/180mm Diameter of the head:1.8mm Carbon steel Packed by PP hanger
	

Code	Description
INGCO-HCCP011802	Straight head circlip Plier Internal circlip plier Size:7"/180mm Diameter of the head:1.8mm Carbon steel Packed by PP hanger
	

Code	Description
INGCO-HCCP011752	Bent head circlip Plier Internal circlip plier Size:7"/180mm Diameter of the head:1.8mm Carbon steel Packed by PP hanger
	

Pliers & Grips

Code	Description
INGCO-HICP01180	Size:7"/180mm Satin finish,insulated handle Stand high pressure,1000V Packed by PP hanger
	

Code	Description
INGCO-HICP01200	Size:8"/200mm Satin finish,insulated handle Stand high pressure,1000V Packed by PP hanger
	

Code	Description
INGCO-HIDCP01160	Size:6"/160mm Satin finish,insulated handle- Stand high pressure,1000V Packed by PP hanger
	

Code	Description
INGCO-HILNP01200	Size:8"/200mm Satin finish,insulated handle- Stand high pressure,1000V Packed by PP hanger
	

Cutters

Code	Description
INGCO-HHCCB0210	Heavy duty cable cutter Size:10"/250mm Black finish and polish55# Carbon steel Packed by half double blister
	

Code	Description
INGCO-HPC0232	Copper and aluminum pipe cutter Cutting diameter:3-32mm With high Quality blade Aluminium knob Packed by sliding card
	

Code	Description
INGCO-HPC0142	Can cut copper pipe & aluminum pipe & steel pipe Cutting diameter:10-42mm With high Quality blade Packed by carton box
	

Screwdrivers- Set

Code	Description
INGCOHSGT280608	6Pcs Go-Through Screwdriver Set S2 industrial steel Hex shank 1pcs SL6.5*6*100 1pcs SL6.5*6*150 1pcs SL8.0*8*200 1pcs PH2*6*100 1pcs PH2*6*150 1pcs PH3*8*200 Packed by PP hanger



Code	Description
INGCO-HKSD0828	8 pcs screwdriver set INGCO new design handle Material:CR-V Round blade 1pcs SL3.0*3*75 1pcs SL5.5*5*100 1pcs SL6.5*6*150 1pcs SL6.5*6*38 1pcs PH0*3*75 1pcs PH1*5*75 1pcs PH2*6*125 1pcs PH2*6*38 Packed by PP hanger



Code	Description
INGCO-HKSD0718	7PCS precision screwdriver set INGCO new design handle New plastic box Include:SL2.0*50,SL2.5*50,SL3.0*50,PH00*50,PH0*50,T6*50,T8*50 Material:CR-V Ergonomic comfort grip handle Packed by plastic box



Code	Description
INGCO-HKSD0348	32PCS precision screwdriver set 1Pcs INGCO Style handle 1Pcs 4X60mm bits holder 30PCS 4X28mm bits:SL1.5,SL2,SL2.5,SL3,SL3.5,SL4,PH000,PH00,PH0,PH1,T4,T5,T6,T7,T8,T9,T10,T15,T20,H0.9,H1.3,H1.5,H2,H2.5,H3,H4,Y2,U2.6,Five Star0.8,Five Star1.2 Five Star0.8,Five Star1.2 is suitable for iPhone and iPad Packed by plastic box



Code	Description
INGCO-AKISD0808	8 pcs Ratchet Screwdriver Set Include:1pcs High Quality Ratchet Handle(INGCO new design) 7pcs 30mm Screwdriver bits SL5,SL6,PH1,PH2,PH3,T15,T20 Packed by half double blister



Code	Description
INGCO-HKSD0268	26 PCS screwdriver bit set Include:1pcs INGCO Style Ratchet Holder 18pcs 65mm Screwdriver bit PH0,PH1,PH2,PH3,PZ1,PZ2,PZ3,SL3,SL4,SL5,SL6,SL7,T10,T15,T20,T25,T27,T30 6pcs Power sleeve 5mm,6mm,7mm,8mm,9mm,10mm Material:CR-V 1pcs pouch colour box for presentation Packed by double blister



Screwdrivers - Insulated

Code	Description
INGCOHISD816150	CR-V,SL6.5×150 INGCO new design handle Round shank1000V VDE Certification Packed by plastic hanger



Code	Description
INGCOHISD81PH060	CR-V,PH0×60 INGCO new design handle Round shank1000V VDE Certification Packed by plastic hanger



Code	Description
INGCOHISD81PH180	CR-V,PH1×80 INGCO new design handle Round shank1000V VDE Certification Packed by plastic hanger



Code	Description
INGCOHISD81PH2100	CR-V,PH2×100 INGCO new design handle Round shank1000V VDE Certification Packed by plastic hanger



Screwdrivers - Insulated

Code	Description
INGCOHISD81PZ2100	CR-V,PZ2×100 INGCO new design handle Round shank1000V VDE Certification Packed by plastic hanger



Code	Description
INGCO-HKISD0608	6 PCS Insulated Screwdriver Set SL3.0×75 SL4.0×100 SL6.5×150 PH0×60 PH1×80 PH2×100 INGCO new design handle Use Aluminum frame with 4pcs Screw and 4pcs Screw Plug Round shank1000V VDE Certification Packed by double blister



Chisels

Code	Description
INGCOHCCL811910	Head size:19mm Handle size:16mm Length:254mm Packed by plastic hanger



Code	Description
INGCOHCCL812512	Head size:25mm Handle size:19mm Length:305mm Packed by plastic hanger



Code	Description
INGCOHCC8141016	Head size:4mm Handle size:16mm Length:254mm Packed by plastic hanger



Code	Description
INGCOHCC8141219	Head size:4mm Handle size:19mm Length:305mm Packed by plastic hanger



Rivet Guns

Code	Description
INGCO-HR105	Size:10.5" Aluminium alloy body Applicable rivet size:2.4mm, 3.2mm,4mm,4.8mm Packed by double blister



Code	Description
INGCO-HFOR321	Size:815mm,32" Applicable rivet size:3.2mm,4mm, 4.8mm,6mm,6.4mm Packed by colour box



Knives

Code	Description
INGCO-HUK618	Blade size:61x19mm SK5 blade with 6 blades Zinc alloy shell Net weight:256g pack by double blister Packed by double blister



Code	Description
	Blade size:61x19mm With 5PCS SK5 blades Zinc alloy body Pack by double blister



Caulking Guns

Code	Description
INGCO-HCG0112	12" aluminum caulking gun Length:305mm Diameter:51mm With 1pcs plastic adaptor Packed by paper card



Code	Description
INGCO-GRG015001	Heavy-Duty Grease Gun Taiwan Quality Capacity:400CC / 14Oz Loading way:14Oz Cartridge / 400CC Bulk Working Pressure:4500psi Burst Pressure:10000psi Material:1.2mm Steel tube + Aluminum-Cast Standard Accessory: 1pcs 12" High Pressure Flexible Nylon Hose 1pcs Metallic Bend Spout Packed by colour box



Chalk Line Reel & Allen Key Sets

Code	Description
INGCO-HCLR0130	Chalk line reel Length: 30m With 1 bottle chalk With 1 pcs spirit bubble Packed by double blister



Code	Description
INGCO-HHK13091	9pcs torx key set Material:Cr-V Size:T10-T50Long arm Heat treatment and chrome plated Packed by double blister



Chalk Line Reel

Code	Description
INGCO-HHK11091	9pcs hex key set Material:Cr-V Size:1.5-10mm Long arm Heat treatment and chrome plate Packed by double blister



Code	Description
INGCO-HHK12091	9pcs ball point hex key set Material:Cr-V Size:1.5-10mm Long arm Heat treatment and chrome plate Packed by double blister



Measuring Tools

Code	Description
INGCO-HSMT0803.1	Length & width:3mx16mm Self lock function Only metric Double button With all rubber cover Packed by label



Code	Description
INGCO-HSMT08052.1	Length & width:5mx19mm Self lock function Only metric Double button With all rubber cover Packed by label



Code	Description
INGCO-HSMT0805.1	Length & width:5mx25mm Self lock function Only metric Double button With all rubber cover Packed by label



Code	Description
INGCO-HSMT0808.1	Length & width:8mx25mm Self lock function Only metric Double button With all rubber cover Packed by label



Code	Description
INGCO-HSMT0810.1	Length & width:10mx25mm Self lock function Only metric Double button With all rubber cover Packed by label



Code	Description
INGCO-HSMT88052.1	Length & width:5mx19mm Only metric Nylone blade Double side metric printing Double hook of blade Stronger clip INGCO unique design Packed by double blister



Code	Description
INGCO-HSMT8805.1	Length & width:5mx25mm Only metric Nylone blade Double side metric printing Double hook of blade Stronger clip INGCO unique design Packed by double blister



Code	Description
INGCO-HSMT8808.1	Length & width:8mx25mm Only metric Nylone blade Double side metric printing Double hook of blade Stronger clip INGCO unique design Packed by double blister



Code	Description
INGCO-HLDD0601	Measuring Range:0.05-60m Measuring Accuracy:±1.5mm Laser Type:635nm <1mW Class2 Operating temp:-10°C ~ +50°C Storage temp:-20°C ~ +65°C Historical Measurements:50 values Splash Proof/Dust Protected:IP54 Batteries:AAA, 2x1.5V, up to 5000 measurements Packed by colour box



Code	Description
INGCO-HMSL01030	Length:225mmMaterial:Aluminum With magnetic With 3 vials Packed by colour sleeve



Code	Description
INGCO-HSL08030	Length:30cm Double side milled 0.5mm/m accurate vials Thickness:1.5mm V-shape slot for measuring objects with round surface Packed by colour sleeve



Code	Description
INGCO-HSL08040	Length:40cm Double side milled 0.5mm/m accurate vials Thickness:1.5mm V-shape slot for measuring objects with round surface Packed by colour sleeve



Measuring Tools

Code	Description
INGCO-HSL08060	Length:60cm Double side milled 0.5mm/m accurate vials Thickness:1.5mm V-shape slot for measuring objects with round surface Packed by colour sleeve



Code	Description
INGCO-HSL08080	Length:80cm Double side milled 0.5mm/m accurate vials Thickness:1.5mm V-shape slot for measuring objects with round surface Packed by colour sleeve



Code	Description
INGCO-HSL08100	Length:100cm Double side milled 0.5mm/m accurate vials Thickness:1.5mm V-shape slot for measuring objects with round surface Packed by colour sleeve



Code	Description
INGCO-HSL38030M	Length:30cm Double side milled 0.5mm/m accurate vials Thickness:1.5mm 2 Pcs powerful magnets Double flat surfaces design Packed by colour sleeve



Code	Description
INGCO-HSL08060D	Length:60cm Measuring ranger:0~360°(4*90°) Measuring accuracy:±0.2 3 Pcs powerful magnets Double side milled 0.5mm/m accurate vials Thickness:1.5mm Double flat surfaces design Packed by colour box



Code	Description

Personal Protection Equipment

Code	Description
INGCO-HGNG01	Size:XL Use for oil environment (less oil) worker etc. Nitrile coated palm, smooth and rough-texture palm finish. Packed by poly bag



Code	Description
INGCO-HGMG01-XL	Size:XL Microfibre material palm provide dexterity to utilize tools and equipments Pack by paper hanger



Code	Description
INGCO-HGMG02-XL	Size:XL Microfibre material palm with PU leather reinforced on palm enhance extreme abrasion resistance. Rubber on back prevent hand from hazards in dark. Pack by paper hanger



Code	Description
INGCO-HGVC01	Size:10" Use for driver,machining operator etc. Cow split leather gloves Full palm, full lining Packed by poly bag



Code	Description
INGCO-HGVC02	Size:10" Use for driver,machining operator etc. Cow split leather gloves Full palm, full lining Packed by poly bag





Code	Description
INGCO-HGVW02	Length:16" Use for professional welding worker etc. Cow split leather welder gloves, one piece back, full lining full palm with double palm Packed by poly bag





Personal Protection Equipment

Code	Description
INGCO-WM101 	Welding mask Material:100% PPGlass size:108*50*3mm,movable type glass 1 pcs clear protection glass Packed by label
INGCO-HFSPC01 	Impact resistant visor Brim protects forehead from outside injure Headgear with adjustable knobs, with antibacterial sweatband Packed by label

Code	Description
INGCO-AHM008 	Viewing Area:92×42mm Cartridge Size:110×90×9mm Arc Sensor:2 Light State:DIN 4 Dark State:Variable shade, 9 ~13 Shade Control:External,Variable Power On/Off:Fully Automatic Sensitivity Control:AUTO UV/IR Protection:DIN 16 Power Supply:Solar cells+2*CR2032 Lithium batteries Switching Time:1/15000S,from Light to Dark Dark to Light(Delay):0.1-1.0 Auto Low Amperage TIG:≥10amps(DC), ≥10amps(AC) Grinding Function :YES Low Volume Alarm:YES Operating Tep:-5°C~+55°C Storing Tep:-20°C~+70°C Packed by colour box

Code	Description
INGCO-HSG04 	The length of temple:4 different positions Integrated encircling type design gives flank protection Packed by double blister

Code	Description
INGCO-HSG05 	Conforms to ANSI Z87.1 and CE EN166 Full-view full-slice structure prevents UV and withstands impact Packed by double blister

Code	Description
INGCO-HSG02 	Has supple and lightweight PVC frame as well unique air hole design. High-impact polycarbonate lenses have high transparency comfortable for wearing. Packed by poly bag

Code	Description
INGCO-HSG06 	Material:high-performance polycarbonat Dark shade:8 Light weight,comfortable to wear,wide visual field Packed by double blister

Code	Description
INGCO-HSGW01 	Flip design with open-close locking positioning, easy to use Flexible PVC body Indirect ventilation design. Inner lenses are clear, outer lenses adopt coloured inorganic glass. Packed by poly bag

Code	Description
INGCO-HDM01 	EN 149:2001 CE0121 Class: FFP2 Made with Grade P2 Four layer Materials: Polypropylene,PP filter fibre,and Polyester Suggested applications for grinding,sanding, and sweeping jobs. Packed by colour box,20pcs/box

Code	Description
INGCO-HEM01 	Impact-resistant ABS shell body,soft foam pad NRR:24dB Packed by paper card

Code	Description
INGCO-HEP02 	Conforms to ear structure,safe and sanitary Made from polyurethane foam,smooth and ultra supple superior noise reuction effect, let operators keep acute hearing in noise ambient Packed by poly bag

Tool Bags

Code	Description
INGCO-HTBG05	 <p>Size:13" Rigid frame for easy opening and access Internal & external pockets for additional storage capacity Packed by paper card</p>

Code	Description
INGCO-HTBG03	 <p>Size:16" Rigid frame for easy opening and access Reinforced plastic base for durability Internal pockets for additional storage capacity Adjustable shoulder strap included Packed by paper card</p>

Code	Description
INGCO-HTBG04	 <p>Size:24" Rigid frame for easy opening and access Reinforced plastic base for durability Internal pockets for additional storage capacity Adjustable shoulder strap included Packed by paper card</p>

Code	Description
INGCO-HTBP02031	 <p>Size:2pcs L26*W23cm 1pcs L15*W13cm Adjustable belt(92-127cm) 14pcs pockets 2pcs hammer holders Material:600D polyester Various pockets for tools Packed by paper card</p>

Torches

Code	Description
INGCOHFL013AAA1	 <p>Aviation grade aluminum alloy:6N01-T6 CREE XPE2 R3 LED 1W Brightness:135 lumens Use alkaline 3AAA battery Tail light switch Waterproof grade IPX-4 Diameter/length :32mm/126.5mm, Weight:105g(without battery) Packed by double blister</p>

Code	Description
INGCO-HHL013AAA2	 <p>CREE XPE2-R3 LED Brightness: Max:180 lumens Low:45 lumens Use alkaline 3AAA battery Max 50m beam distance IPX4 raining resistant Packed by double blister</p>

INGCO

PROFESSIONAL TOOLS MADE AFFORDABLE



Johannesburg:

+27 (0) 10 900 4500

sales@umqondo.com

**PO BOX 74212
TURFFONTEIN
2140**

**93 TURFFONTEIN Rd.
TURFFONTEIN
2140**

TEL NO: +27 10 900 4500

FAX NO: +27 11 434 1594

EMAIL: sales@umqondo.com

WWW.UMQONDO.COM